



HY310X ENOB Test User Manual

Table of Contents

1. ENOB AND NOISE FREE DESCRIPTION	3
2. HARDWARE/SOFTWARE INSTALLATION	4
2.1 MINIMUM SYSTEM REQUIREMENTS	4
2.2 INSTALLATION AND REMOVAL.....	4
3. SOFTWARE MENU DESCRIPTION	10
3.1 OPTION	10
3.1.1 Setup	10
3.1.2 RAM Panel	11
3.1.3 REG Panel.....	12
3.1.4 ADC Panel.....	12
3.2 USB SCAN	13
3.3 READ RAM.....	13
4. ENOB TEST	14
5. HARDWARE DESCRIPTION	16
5.1 USB ENOB Test Board Description.....	16
5.2 HY310x Demo Board Description	17
6. QUESTION OBVIATION	18
7. REVISION HISTORY	19

1. ENOB and Noise Free Description

RMS Noise that generated from Sigma Delta ADC is the minimum voltage value of distinguishable sampling signal. Hence, ENOB (Effective Number of Bits) is calculated by the ratio of RMS Noise and Full Scale Range. However, RMS Noise must be calculated by many average times. Insufficient sampling times can only represent RMS Noise for a specific period of time instead of the entire ADC operation. Therefore, RMS Noise operation times cannot be less than 1024 times.

However, Noise Free Bit represents that ADC output value count is not rolling. Noise Free Bits are stable ADC output performance. Bit operation is defined as Peak-to-Peak Noise and Full Scale Range ratio.

RMS Noise Equation:

$$\text{平均Count} \rightarrow \text{Average} = \frac{\sum_{k=1}^n \text{ADC}[k]}{n} \quad (1)$$

$$\text{RMSNoise} = \frac{V_{\text{RFE}} \times \sqrt{\frac{\sum_{k=1}^n (\text{ADC}[k] - \text{Average})^2}{n}}}{2^{\text{Scale}}} \quad (2)$$

In the above equation, n represents total sampling number of ADC and Scale represents ADC total output bits. ENOB and Noise Free Bits can be gained by taking Equation 1 and Equation 2 to the following equation:

$$\text{ENOB} = \log_2 \left(\frac{\text{FSR}}{\text{RMSNoise}} \right) = \frac{\ln \left(\frac{\text{FSR}}{\text{RMSNoise}} \right)}{\ln(2)} \quad (3)$$

$$\text{NoiseFreeBits} = \log_2 \left(\frac{\text{FSR}}{\text{Peak-to-Peak Noise}} \right) = \frac{\ln \left(\frac{\text{FSR}}{\text{Peak-to-Peak Noise}} \right)}{\ln(2)} \quad (4)$$

Equation of Peak-to-Peak Noise:

$$\text{Peak-to-Peak Noise} = \frac{V_{\text{REF}} \times (\text{ADC}_{\text{Max}} - \text{ADC}_{\text{Min}})}{2^{\text{Scale}}} \quad (5)$$

2. Hardware/Software Installation

2.1 Minimum System Requirements

1. Hardware Requirements:

IBM AT/ATX PC PENTIUM® or any above compatible type

Memory size > 32MB (>256MB is recommended)

Resolution > VGA 1024×768, 256-color display

Hard discs space > 10MB

USB port

2. Operation System

Windows™ 98SE

Windows™ 2000

Windows™ XP

Windows™ Vista

Windows™ 7

Not supportive for 64 bit window, *nix and OSX operation system. Menu could be unreadable code when operating in non-traditional Chinese operation system.

2.2 Installation and Removal

1. Software Installation

For certain operation system, it requires Administrator identity to install software to the computer.

- Look for Setup.exe and execute it from CD-ROM menu or unzip file. Proceeding the installation procedures as frame indicates. As shown in below dialog window.

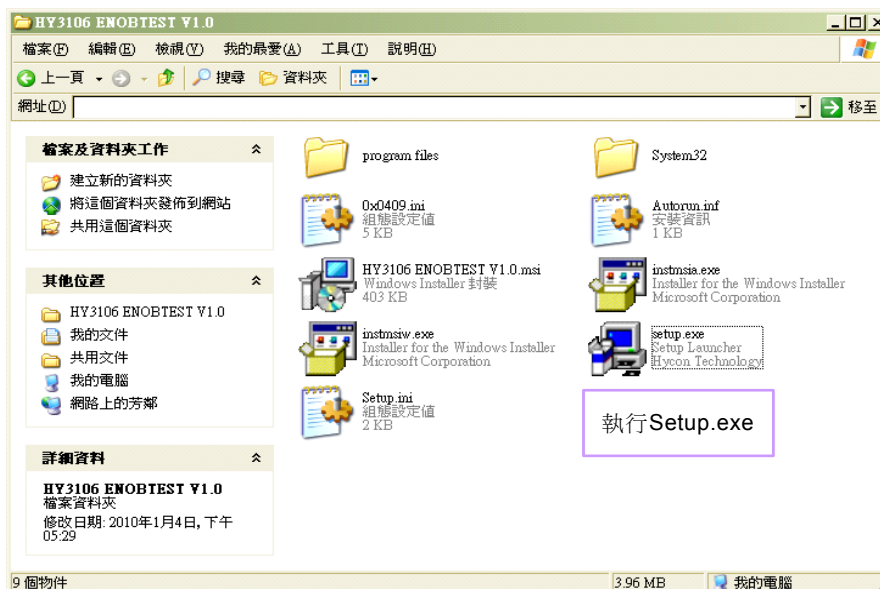

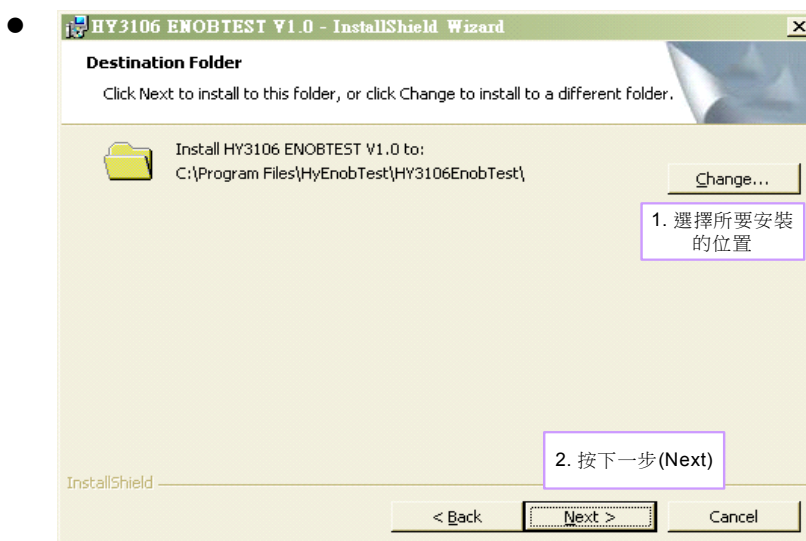
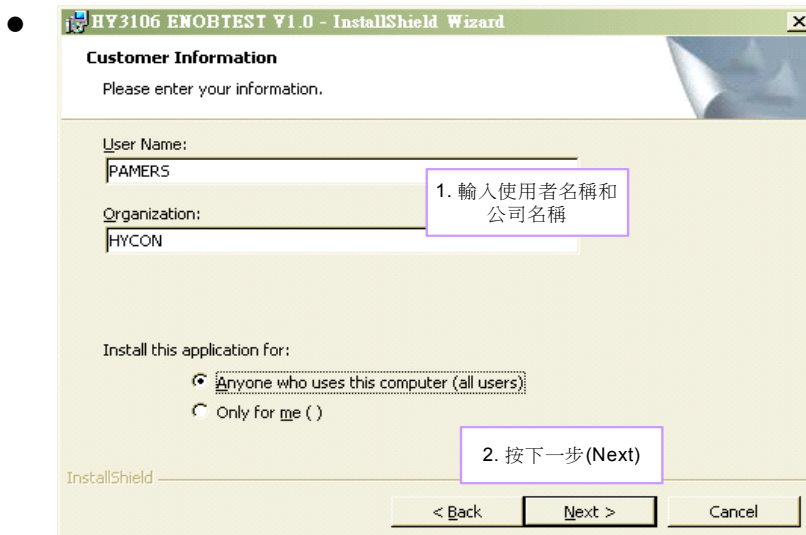
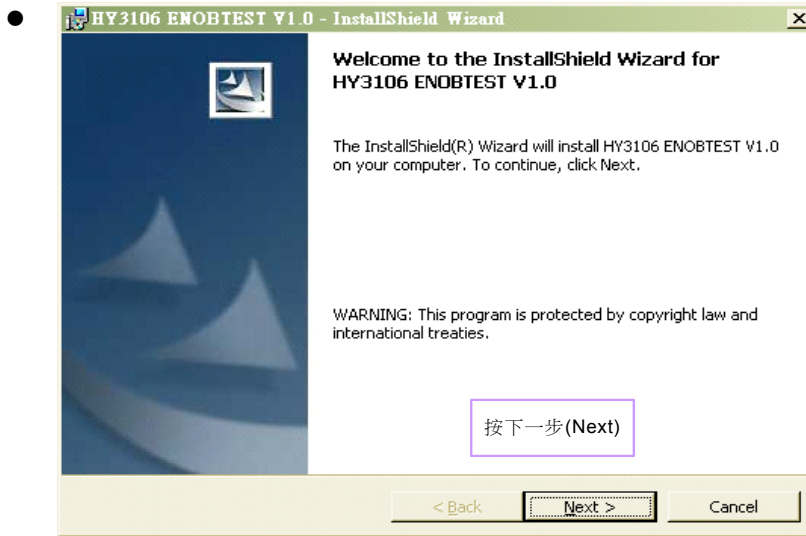

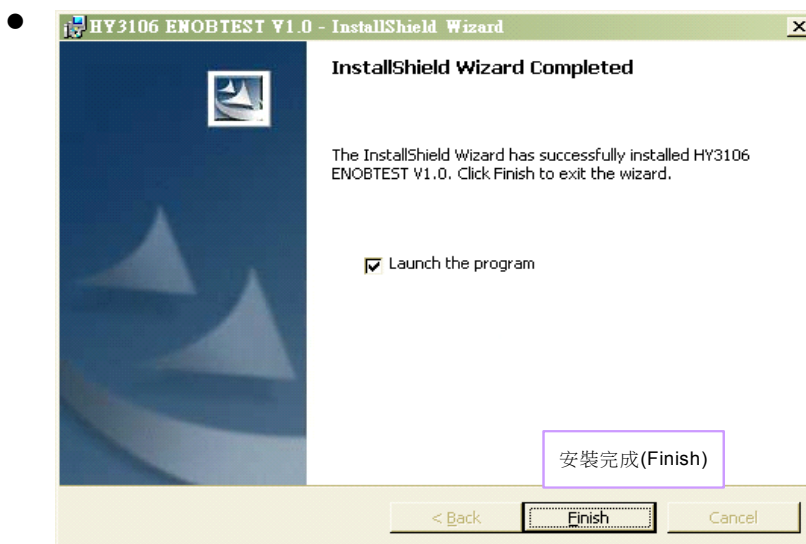
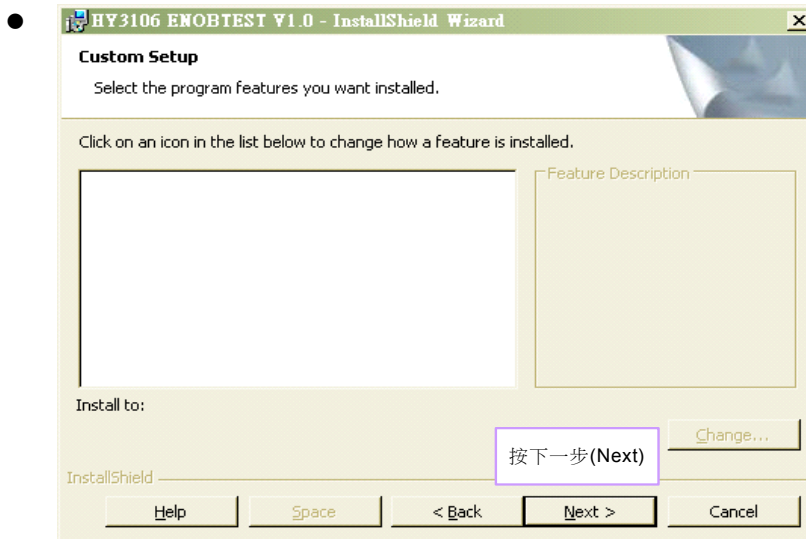

2. Software Removal

To certain operation systems, it requires Administrator identity to remove software.

- Control panel (Start → setup → control panel) , clicking "install/remove program".



- After pressing "Yes", the program will be removed but no relative window will pop up.



3. Software Installation

For certain operation systems, it requires Administrator identity to install hardware driving program.

- When connecting PC and USB ENOB Test Board via USB wire, PC will find a new hardware.
Please select "Install from a list or specific location (Advance)" and proceeds next step.



- Select "Don't search. I will choose the driver to install" and press next.

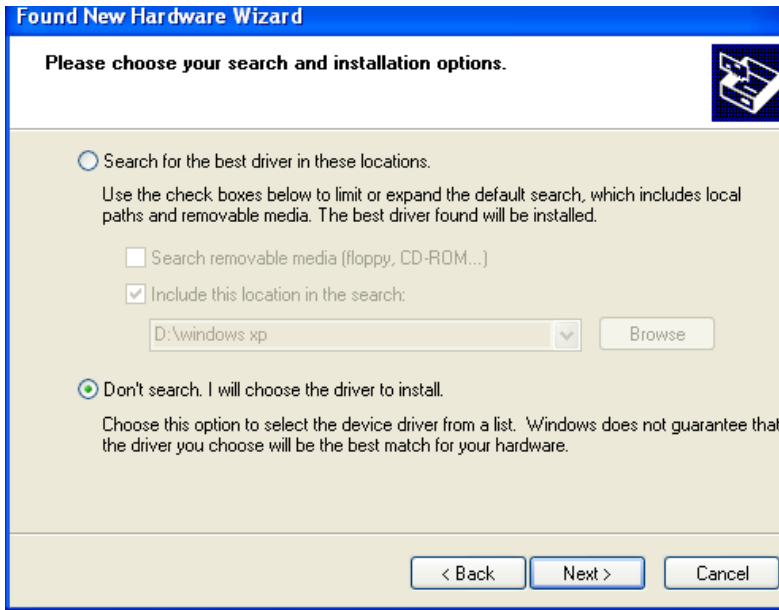

- Click "Have Disk".

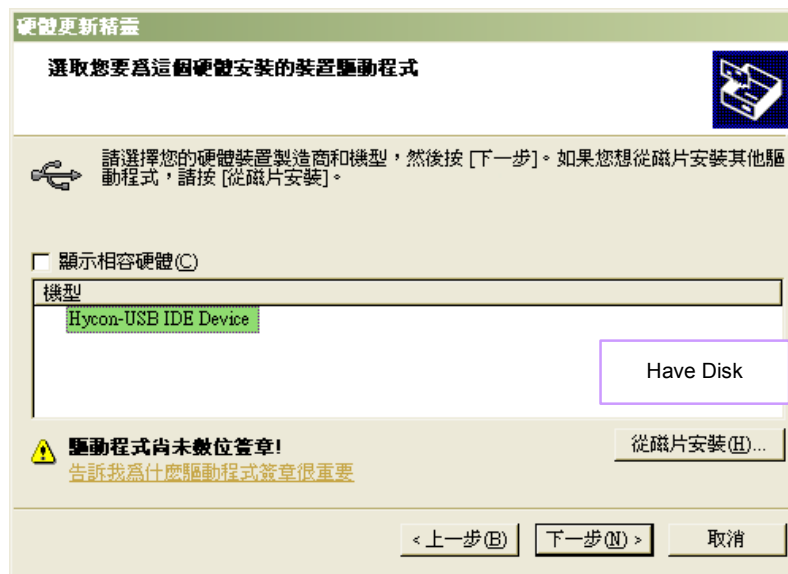

- Click browse and assign driving program menu, the default location is ""C:\ProgramFiles\HyEnobTest\HY3106EnobTest\Driver\"" and press yes.

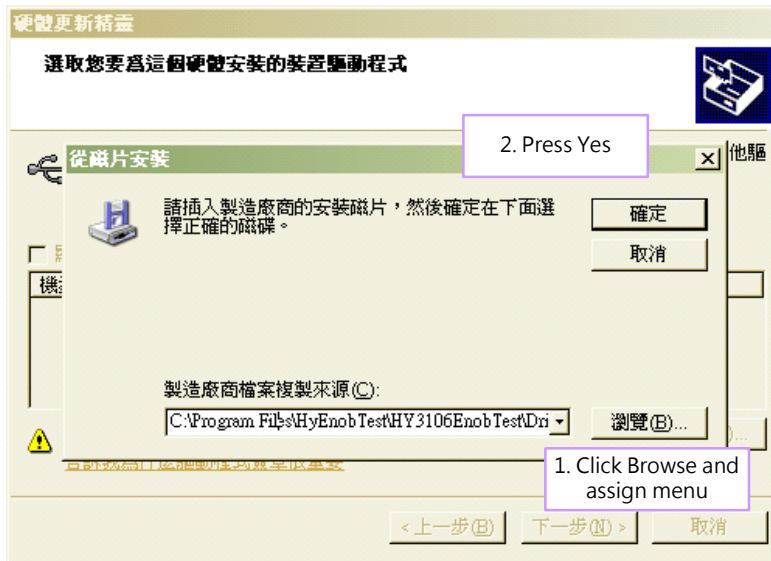

- Select "Hycon-USB Temperature Reader Device" and press next. After compatibility warning shows up, please press "continue installation".

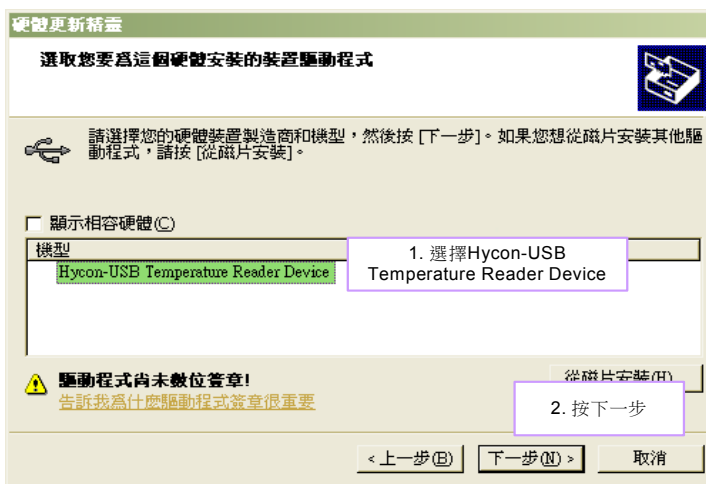

- Install complete



3. Software Menu Description

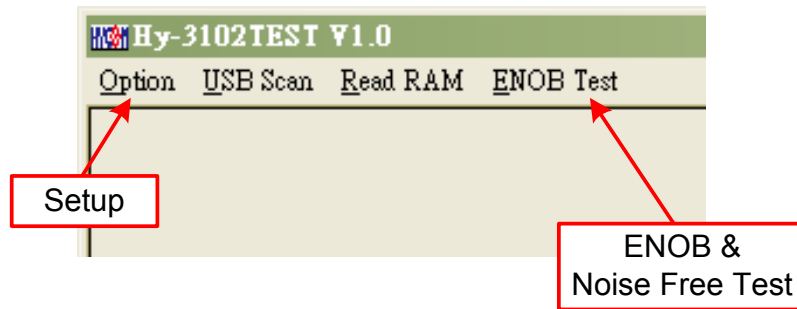

Figure 3-1

3.1 Option

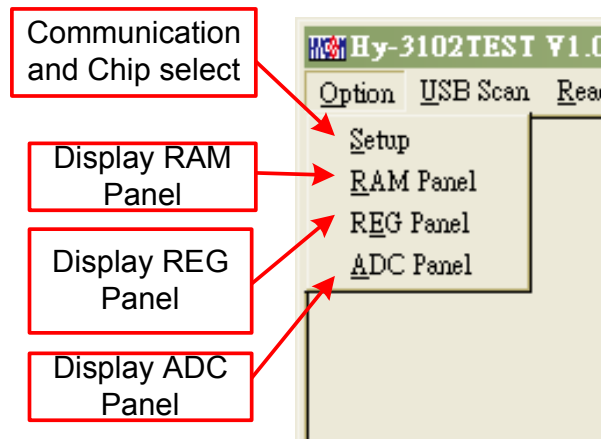

Figure 3-2

3.1.1 Setup

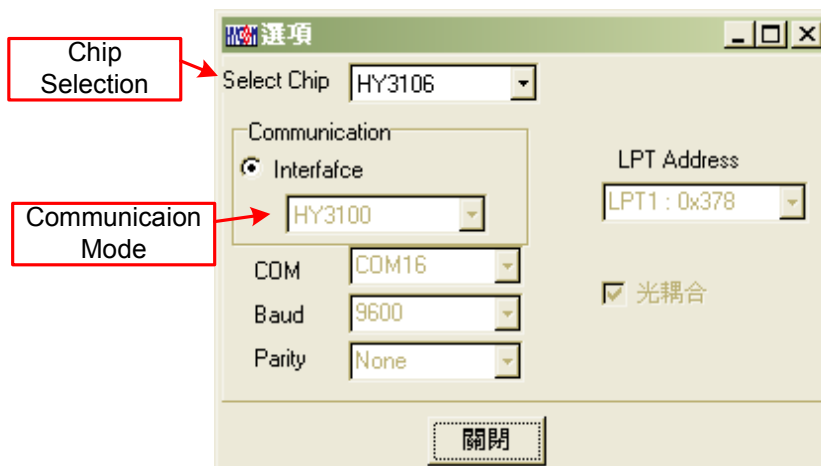

Figure 3-3

When test tool and HY310X series are connected, the device number and communication mode is set. User needs not to make other selection

3.1.2 RAM Panel

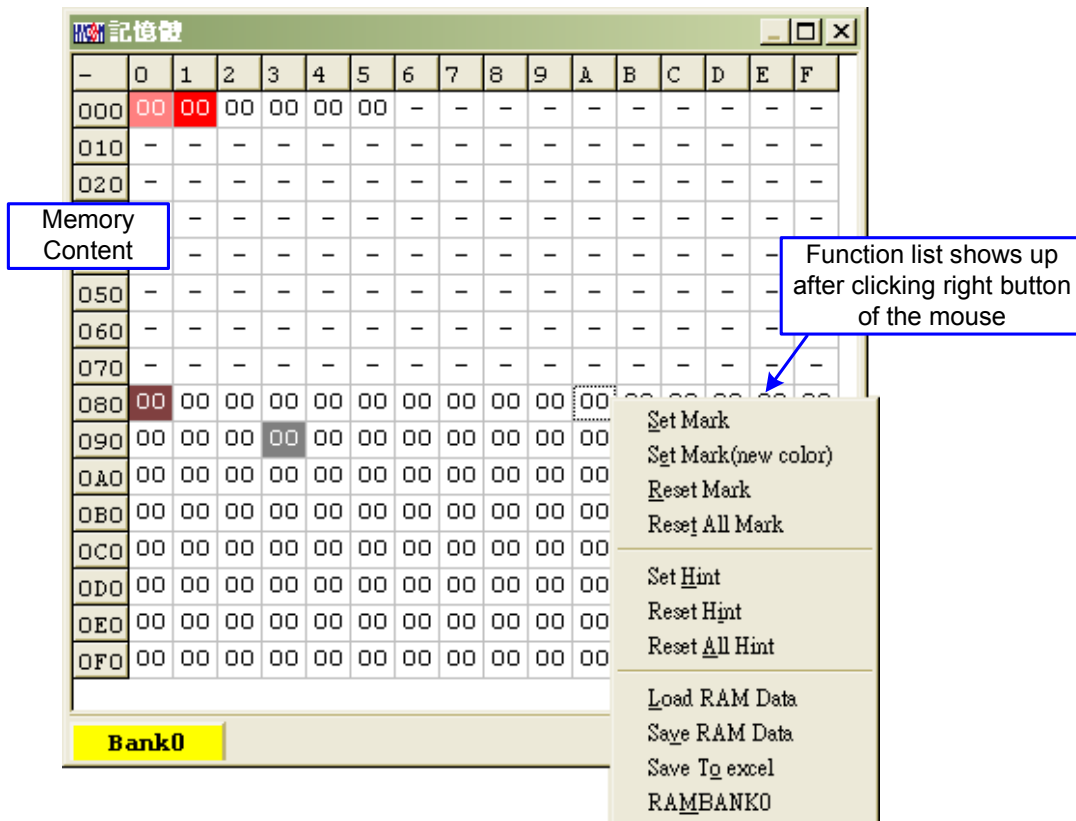

Figure 3-4

- Open RAM window, memory content of the chip will be displayed.
- If the address is inexistent, it will display —.
- If the address underlined number, it means Hint has been configured.
- The data in the address can be directly amended by clicking the left button on the address.
- By double-clicking the left button on the address, the window of amending data will show up.
- For detailed operation description, please refer to Chapter 3.2 of HY-IDE software user manual.

3.1.3 REG Panel

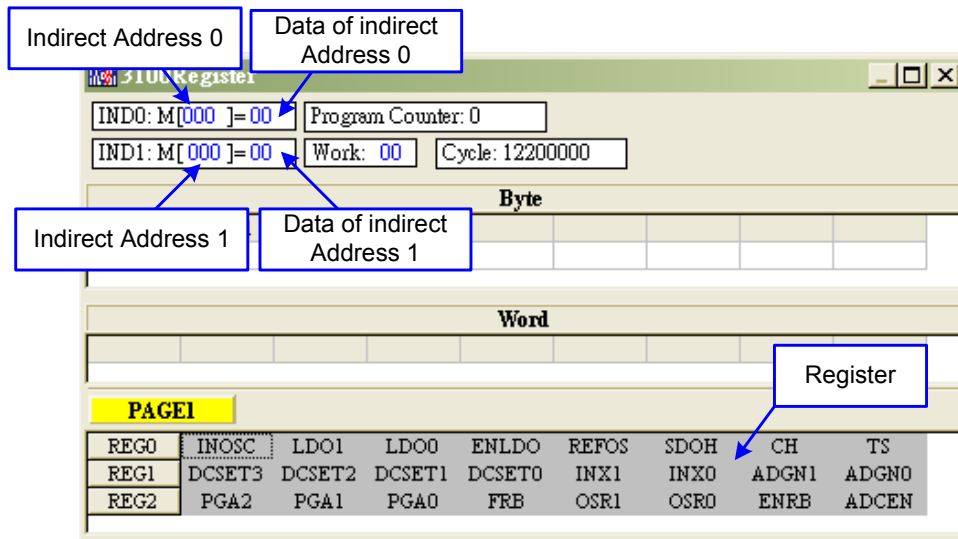

Figure 3-5

Please refer to Chapter 3.3 Register window operation of HY-IDE software user manual.

3.1.4 ADC Panel

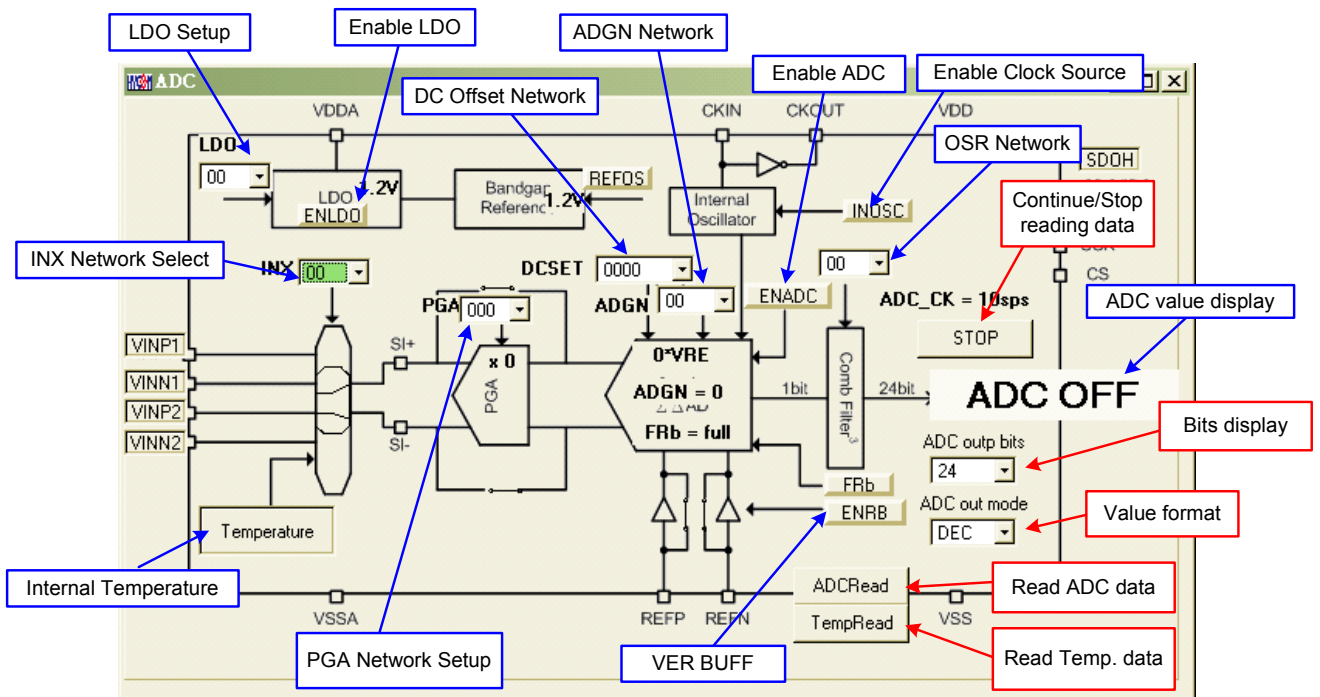

Figure 3-6

- Please refer to Chapter 3.6 of HY-IDE Software User Manual, ADC window operation.
- Setup parameters; please refer to HY310x Series datasheets.
- **Please do not change setup value when ADC reads data, this may lead to unpredictable consequences.**
- ADC value display:
 - (1) Select ADC value output format, Hex or Dec format output.

- (2) Select Bit of ADC value, output from 8 to 24 Bit.
- (3) Press read ADC or temperature sensor data. ADC output value will be display immediately; the format can be configured by users.
- (4) Press continue reading data, the ADC output data will be displayed in Dec format.

3.2 USB Scan

When USB port is connected to ENOB control board, “USD On Line” will display as like the following

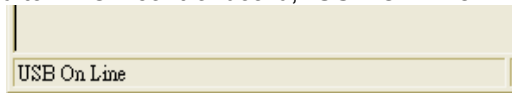

Figure 3-7

3.3 Read RAM

After “USB Scan” completed and “USB on Line” confirmed, please implement Read RAM. The RAM and Registers of chip will be read to the buffer zone of PC. It will affect RMS Noise and Peak-to-Peak Noise operation of ENOB Test.

4. ENOB Test

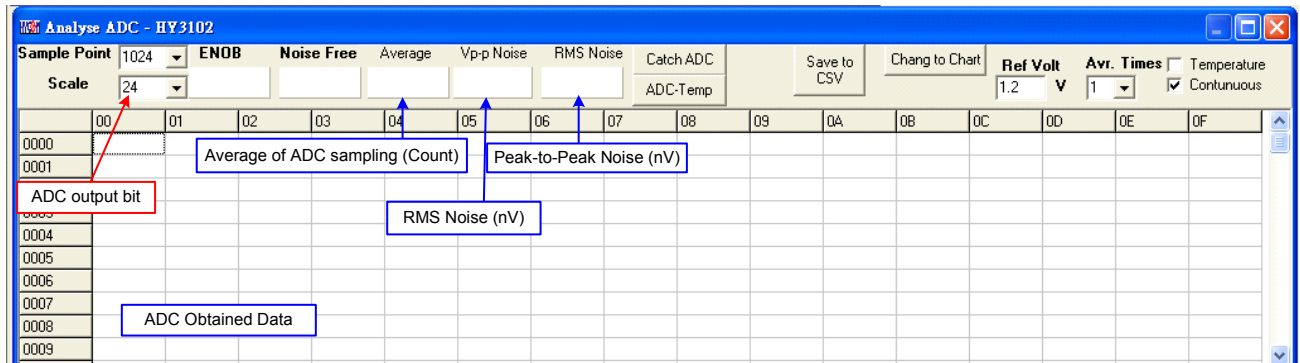

Figure 3-8

1. Sample Point

ADC sample point of "Catch ADC" and "ADC-Temp" function. Minimum sample of OTP ADC output is 256 records and maximum is 65536 records.

2. Scale

ADC output bit. Minimum ADC output bit is 8-bit and maximum is 24-bit.

3. ENOB

Display ENOB, the calculation is shown as Equation 3, the unit is bit.

4. Noise Free

Display Noise Free Bits, as Equation 4, the unit is Bit.

5. Average

Display sampling average value of ADC, as Equation 1, the unit is Counts.

6. Vp-p Noise

Display Peak-to-Peak Noise, as Equation 5, the unit is nV.

7. RMS Noise

Display RMS Noise, as Equation 2, the unit is nV.

8. Catch ADC

Real-time catch and display ADC value in order. **Please do not implement this function when ADC setup window displays data in continuous mode.**

9. ADC-Temp

Real-time display ADC value and temperature sensor value in order.

10. Save to CSV

Save the display value to *.CSV file, including ENOB, Noise Free, Average, Vp-p Noise and RMS Noise.

11. Change To Chart

Switch chart and value in value display zone.

12. Ref Volt

Input Reference Voltage (unit: V).

13. Avr. Times

Select software average, the value is display zone will perform average again, according to the times of selection and then display in value display zone.

5. Hardware Description

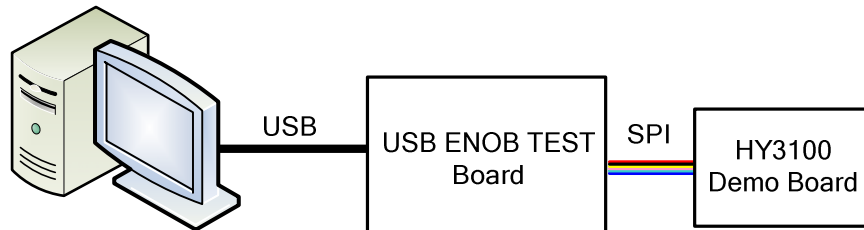

Figure 5-1

PC transmits Command to USB ENOB Test Board; USB ENOB Test Board configures and reads ADC value via SPI from Hycon HY310x Demo Board.

5.1 USB ENOB Test Board Description

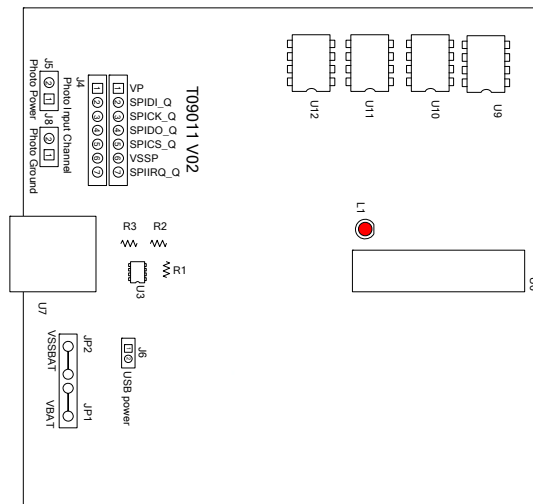

Figure 5-2

1. J4 : Optical Coupler SPI Port

J4 description

PIN 1 → VP, powered by optical coupler IC (U8~U13), J5 and J8 must be opened to completely isolate power. J5 and J8 must be short to use common power supply.

PIN 2 → SPIDI_Q, optical coupler DI signal wire.

PIN 3 → SPICK_Q, optical coupler CK signal wire.

PIN 4 → SPIDO_Q, optical coupler DO signal wire.

PIN 5 → SPICS_Q, optical coupler CS signal wire.

PIN 6 → VSSP, optical coupler Ground.

2. JP1, JP2, J6 and U3 : Power Supply Circuit

JP1 and JP2 is external power input that supply power to U3 and generates VDD power. Using USB power, J6 is short circuit. Using external 5V power, JP1 and JP2 inputs, J6 is open circuit. Regulated circuit that composed by U3, R1, R2 and R3 generates VDD power. Amending R1, R2 and R3 can change output voltage, the relation is as follows:

$$VDD = 1.240V \times \left(1 + \frac{R1 + R2}{R3} \right) \quad (6)$$

3. U9, U10, U11 and U12 :

Optical coupler IC components

4. U7 : USB Port

Port connecting to PC, is the power source of entire system (5V), 500mA input.

5.2 HY310x Demo Board Description

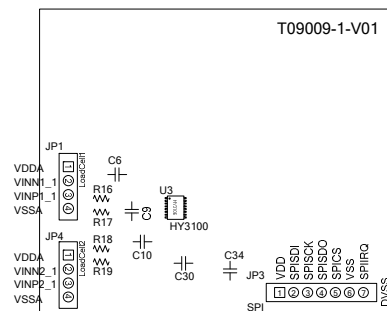

Figure 5-3

1. JP3 : Optical Coupler SPI Port

JP description

- PIN 1 → VDD powered by 3.6V voltage via USB ENOB Test Board
- PIN 2 → SPISDI, DI signal wire
- PIN 3 → SPISCK, CK signal wire
- PIN 4 → SPISDO, DO signal wire
- PIN 5 → SPICS, CS signal wire
- PIN 6 → VSS, Ground.

2. JP1 and JP4 : Signal Input End

JP1 and JP4 description

- PIN 1 → VDDA, supplies 3.3V power
- PIN 2 → VINN1_1, signal input end
- PIN 3 → SINP1_1, signal input end
- PIN 4 → VSSA, Ground.

3. C9 and C10 : Filter Capacitor

0.1uF SMD capacitor

4. U3 : Main Chip

HY310x IC

6. Question Obviation

1. Registers cannot be configured under ADC window?

Communication way and IC selection must be configured first. After executing USB Scan and Read RAM, ADC register value can be configured. If USB is connected and confirmed, configuration still cannot be implemented, please close program and remove USB. After plug in the USB, execute the program again.

2. Configuration of ADC window is relatively slow?

Please do not change any setup when ADC reads data, this might bring about unpredictable results.

3. Can the data obtained include time?

Data obtained from the program includes file that be saved as CSV format but not including time. Users can detect the X axis represents time in graphical display mode, demonstrating in ms. Time recording function will be incorporated in next version of program update.

4. Program cannot be executed, file lack appears and program demands to reinstall.

Please print the error window and message and please contact the distributor who provided this DMM EVA Test Tool to you or directly contact HYCON Technology for further support. We are sorry for the inconvenience this has caused to you.

5. INF error shows up when USB drive program is under installation or is completed and a yellow exclamation mark appears in “device manager”.

Please copy all programs of Driver file in the installation menu to c:\windows\system32\drivers. Reinstall driving program again. If error shows up again, please contact the distributor who provided this DMM EVA Test Tool to you or directly contact HYCON Technology for further support.

7. Revision History

Major differences are stated thereafter:

Version	Page	Revision Summary
V01	All	First Edition