



---

**HY11P41**  
**Datasheet**  
**8-Bit RISC-like Mixed Signal Microcontroller**  
**Embedded 24-Bit  $\Sigma\Delta$ ADC**

## Table of Contents

<b>1. FEATURES .....</b>	<b>5</b>
<b>2. PIN DEFINITION .....</b>	<b>6</b>
2.1. SSOP16 Pin Diagram .....	6
2.2. SOP16 Pin Diagram.....	6
2.3. QFN16 Pin Diagram.....	7
2.4. SSOP16 Pinout I/O Description .....	8
2.5. SOP16 Pinout I/O Description.....	9
2.6. QFN16 Pinout I/O Description.....	10
2.7. Package marker information .....	11
2.7.1. SSOP16 package.....	11
2.7.2. SOP16 package .....	11
2.7.3. QFN16 package .....	12
<b>3. APPLICATION CIRCUIT .....</b>	<b>13</b>
3.1. Bridge Sensor I .....	13
3.2. Bridge Sensor II .....	14
3.3. 4-20mA Two-Wire Current Panel Meter .....	15
<b>4. FUNCTION OUTLINE .....</b>	<b>16</b>
4.1. Internal Block Diagram.....	16
4.2. Related Description and Supporting Documents .....	16
4.3. SD18 Network.....	17
<b>5. REGISTER LIST .....</b>	<b>18</b>
<b>6. ELECTRICAL CHARACTERISTICS.....</b>	<b>19</b>
6.1. Recommended Operating Conditions .....	19

# HY11P41

## Embedded 24-Bit $\Sigma\Delta$ ADC 8-Bit RISC-like Mixed Signal Microcontroller



6.2.	Internal RC Oscillator.....	20
6.3.	Supply Current into VDD Excluding Peripherals Current .....	21
6.4.	Port1~4 .....	22
6.5.	Reset (Brownout, External RST Pin, Low Voltage Detect).....	23
6.6.	Power System.....	25
6.7.	SD18, Power Supply and Recommended Operating Conditions .....	27
6.7.1.	PGA, Power Supply and Recommended Operating Conditions.....	27
6.7.2.	SD18, Performance II (fSD18=250KHz).....	27
6.7.3.	SD18, Temperature Sensor.....	29
6.7.4.	SD18 Noise Performance .....	30
6.8.	Built-in EPROM (BIE).....	32
<b>7.</b>	<b>ORDERING INFORMATION .....</b>	<b>33</b>
<b>8.</b>	<b>PACKAGE INFORMATION.....</b>	<b>34</b>
8.1.	SSOP16 (E016) .....	34
8.1.1.	Package Dimensions .....	34
8.1.2.	Tube Dimensions SSOP16(E016).....	35
8.1.3.	Tape & Reel Information.....	36
8.2.	SOP16(S016).....	37
8.2.1.	Package Dimensions .....	37
8.2.2.	Tube Dimensions SOP16(S016).....	38
8.2.3.	Tape & Reel Information.....	39
8.3.	QFN16(N016) .....	40
8.3.1.	Package Dimensions .....	40
8.3.2.	Tape & Reel Information.....	41

## Attention:

- 1、HYCON Technology Corp. reserves the right to change the content of this datasheet without further notice. For most up-to-date information, please constantly visit our website: <http://www.hycontek.com>.
- 2、HYCON Technology Corp. is not responsible for problems caused by figures or application circuits narrated herein whose related industrial properties belong to third parties.
- 3、Specifications of any HYCON Technology Corp. products detailed or contained herein stipulate the performance, characteristics, and functions of the specified products in the independent state. We does not guarantee of the performance, characteristics, and functions of the specified products as placed in the customer's products or equipment. Constant and sufficient verification and evaluation is highly advised.
- 4、Please note the operating conditions of input voltage, output voltage and load current and ensure the IC internal power consumption does not exceed that of package tolerance. HYCON Technology Corp. assumes no responsibility for equipment failures that resulted from using products at values that exceed, even momentarily, rated values listed in products specifications of HYCON products specified herein.
- 5、Notwithstanding this product has built-in ESD protection circuit, please do not exert excessive static electricity to protection circuit.
- 6、Products specified or contained herein cannot be employed in applications which require extremely high levels of reliability, such as device or equipment affecting the human body, health/medical equipments, security systems, or any apparatus installed in aircrafts and other vehicles.
- 7、Despite the fact that HYCON Technology Corp. endeavors to enhance product quality as well as reliability in every possible way, failure or malfunction of semiconductor products may happen. Hence, users are strongly recommended to comply with safety design including redundancy and fire-precaution equipments to prevent any accidents and fires that may follow.
- 8、Use of the information described herein for other purposes and/or reproduction or copying without the permission of HYCON Technology Corp. is strictly prohibited.

# HY11P41

## Embedded 24-Bit $\Sigma\Delta$ ADC 8-Bit RISC-like Mixed Signal Microcontroller

### 1. Features

- 8-bit RISC, 66 instructions included.
- Operating voltage range: 2.2V to 3.6V, operation temperature range:  $-40^{\circ}\text{C} \sim 85^{\circ}\text{C}$ .
- External Crystal Oscillator and Internal High Precision RC Oscillator, 6 CPU clock rates enable users to have the most power-saving plan.
  - Active Mode 300uA@2MHz
  - Standby Mode 3uA@28KHz
  - Sleep Mode 1uA
- 2K Word OTP (One Time Programmable) Type program memory, 128 Byte Data Memory.
- Brownout detector and Watch dog Timer, prevents CPU from Crash.
- 18-bit fully differential input Sigma-Delta Analog-to-Digital Converter (A/D)
  - Built-in PGA (Programmable Gain Amplifier)  $1/4x \cdot 1/2x \cdot 1x \dots 128x \cdot 10$  input signal gain selection.
  - Built-in Input zero point adjustment can increase measurement range according to different application.
  - Programmable data output rate : 8SPS~2KSPS
- Built-in absolute temperature sensor
- 1.0V and 1.2V internal analog circuit common ground that equips with Push-Pull drive ability to provide sensor driving voltage.
- LVD low voltage detection function has 14 steps of voltage detection configuration and external input voltage detection function.
- VDDA can select 4 different output voltages that equips with 10mA low dropout regulator and fast start function.
- 8-bit Timer A
- 16-bit Timer B module equips with Capture function
- 8-bit Timer C module can generate PWM/PFD waveform.
- Built-in EPROM (BIE)
- Support 6 stack level

### Function List

Model No.	VDD	System Clock	Program Memory (word)	SRAM (byte)	BIE (word)	ADC ENOB (bit x ch)	Sample Rate (sps)	TPS	I/O	Timer (bit x ch)	PWM (bit x ch)	Package
HY11P41	2.2V~3.6V	28KHz~2MHz	2K	128	64	20-bit x 4	8~1953	yes	8xI + 5xIO	8-bit x 2 16-bit x 1	8-bit x 1	SSOP16 SOP16 QFN16

# HY11P41

Embedded 24-Bit  $\Sigma\Delta$ ADC

8-Bit RISC-like Mixed Signal Microcontroller

## 2. Pin Definition

### 2.1. SSOP16 Pin Diagram

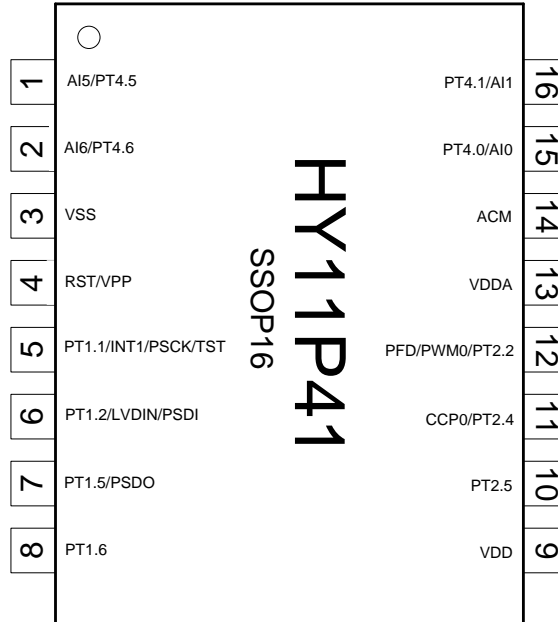

Figure 2-1 HY11P41 SSOP16 Pin Diagram

### 2.2. SOP16 Pin Diagram

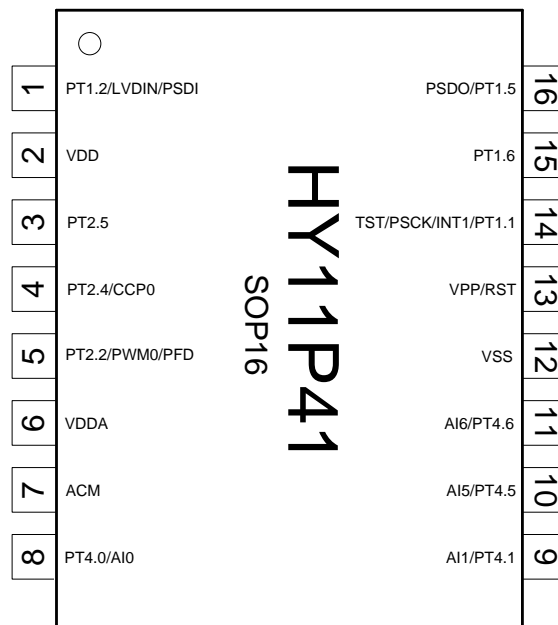

Figure 2-2 HY11P41 SOP16 Pin Diagram

# HY11P41

Embedded 24-Bit  $\Sigma\Delta$ ADC

8-Bit RISC-like Mixed Signal Microcontroller

## 2.3. QFN16 Pin Diagram

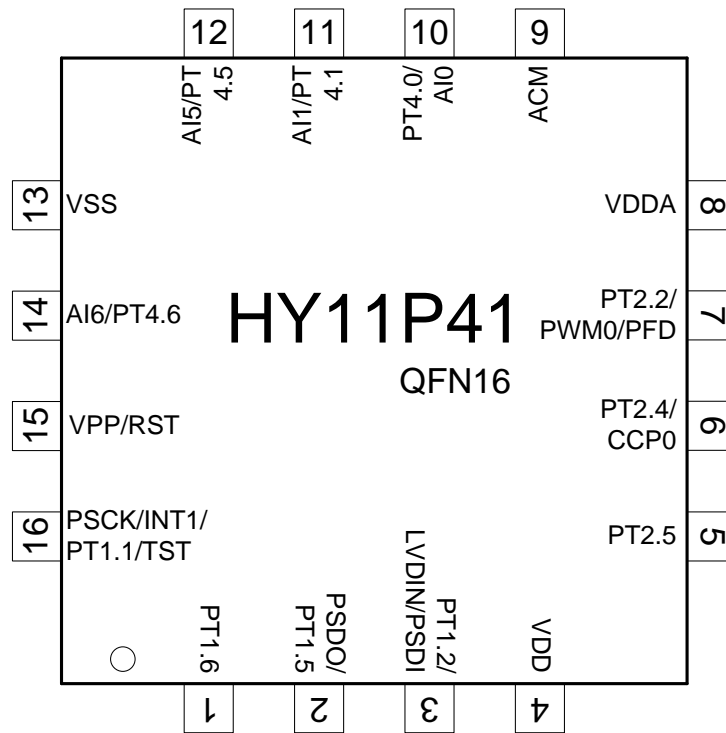

Figure 2-3 HY11P41 QFN16 Pin Diagram

Note 1 : VPP and RST use the same pin. Input voltage cannot exceed 5.8V when not programming EPROM.

Note 2 : TST and PT1.1 use the same pin. Input voltage cannot exceed VDD+0.3V while operating.

Note 3 : If PT1.1 is not configured as external button pin, the anti-interference ability will be enhanced.

# HY11P41

Embedded 24-Bit  $\Sigma$ ADC  
8-Bit RISC-like Mixed Signal Microcontroller



## 2.4. SSOP16 Pinout I/O Description

"I/O" input/output, "I" input, "O" output, "S" Smith Trigger, "C" CMOS features compatible input/output, "P" power supply, "A" analog channel

No.	Pin Name	Pin Characteristics		Function Description
		Pin Type	Buffer Type	
1	AI5/PT4.5	AI5	A	Analog input channel Digital input
		PT4.5	I	
2	AI6/PT4.6	AI6	A	Analog input channel Digital input
		PT4.6	I	
3	VSS	P	P	Ground pin for IC operation voltage
4	RST/VPP	RST	I	Reset the chip EPROM read/write power source
		VPP	P	
5	PT1.1/INT1/PSCK/TST PT1.1 INT1 PSCK TST	I	S	Digital input Interrupt source, INT1 PSCK port of OTP read/write Test mode enable input ( invalid )
		I	S	
		I	S	
		I	S	
6	PT1.2/LVDIN/PSDI	I	S	Digital input LVD external signal input port PSDI port of OTP read/write
		A	A	
		I	S	
7	PT1.5/PSDO	I/O	S	Digital input/output PSDO port of OTP read/write
		I/O	C	
8	PT1.6	I/O	S	Digital input/output
9	VDD	P	P	Chip operation power source
10	PT2.5	I/O	S	Digital input/output
11	PT2.4/CCP0	I/O	S	Digital input/output Capture mode signal port
		I	S	
12	PT2.2/PWM0/PFD	I/O	C	Digital input/output PWM output port PFD output port
		O	C	
		O	C	
13	VDDA	P	P	Regulator output Analog circuit voltage source
14	ACM	P	P	Internal analog circuit grounding pin
15	AI0/PT4.0	AI0	A	Analog input channel Digital input
		PT4.0	I	
16	AI1/PT4.1	AI1	A	Analog input channel Digital input
		PT4.1	I	

Table 2-1 Pin Definition and Function Description



# HY11P41

Embedded 24-Bit  $\Sigma$ ADC  
8-Bit RISC-like Mixed Signal Microcontroller



## 2.5. SOP16 Pinout I/O Description

"I/O" input/output, "I" input, "O" output, "S" Smith Trigger, "C" CMOS features compatible input/output, "P" power supply, "A" analog channel

No.	Pin Name	Pin Characteristics		Function Description
		Pin Type	Buffer Type	
1	PT1.2/LVDIN/PSDI			
	PT1.2	I	S	Digital input
	LVDIN	A	A	LVD external signal input port
2	VDD			
	PSDI	I	S	PSDI port of OTP read/write
		P	P	Chip operation power source
3	PT2.5			
	PT2.5	I/O	S	Digital input/output
4	PT2.4/CCP0			
	PT2.4	I/O	S	Digital input/output
	CCP0	I	S	Capture mode signal port
5	PT2.2/PWM0/PFD			
	PT2.2	I/O	C	Digital input/output
	PWM0	O	C	PWM output port
	PFD	O	C	PFD output port
6	VDDA			
		P	P	Regulator output Analog circuit voltage source
7	ACM			
		P	P	Internal analog circuit grounding pin
8	AI0/PT4.0			
	AI0	A	A	Analog input channel
	PT4.0	I	C	Digital input
9	AI1/PT4.1			
	AI1	A	A	Analog input channel
	PT4.1	I	C	Digital input
10	AI5/PT4.5			
	AI5	A	A	Analog input channel
	PT4.5	I	C	Digital input
11	AI6/PT4.6			
	AI6	A	A	Analog input channel
	PT4.6	I	C	Digital input
12	VSS			
		P	P	Chip operation power source grounding pin
13	RST/VPP			
	RST	I	S	Reset the chip
	VPP	P	P	EPROM read/write power source
14	PT1.1/INT1/PSCK/TST			
	PT1.1	I	S	Digital input
	INT1	I	S	Interrupt source, INT1
	PSCK	I	S	PSCK port of OTP read/write
	TST	I	S	Test mode enable input (invalid)
15	PT1.6			
	PT1.6	I/O	S	Digital input/output
16	PT1.5/PSDO			
	PT1.5	I/O	S	Digital input/output
	PSDO	I/O	C	PSDO port of OTP read/write

Table 2-2 Pin Definition and Function Description

# HY11P41

Embedded 24-Bit  $\Sigma$ ADC  
8-Bit RISC-like Mixed Signal Microcontroller



## 2.6. QFN16 Pinout I/O Description

"I/O" input/output, "I" input, "O" output, "S" Smith Trigger, "C" CMOS features compatible input/output, "P" power supply, "A" analog channel

No.	Pin Name	Pin Characteristics		Function Description	
		Pin Type	Buffer Type		
1	PT1.6	PT1.6	I/O	S	Digital input/output
2	PT1.5/PSDO	PT1.5 PSDO	I/O I/O	S C	Digital input/output PSDO port of OTP read/write
3	PT1.2/LVDIN/PSDI	PT1.2 LVDIN PSDI	I A I	S A S	Digital input LVD external signal input port PSDI port of OTP read/write
4	VDD		P	P	Chip operation power source
5	PT2.5	PT2.5	I/O	S	Digital input/output
6	PT2.4/CCP0	PT2.4 CCP0	I/O I	S S	Digital input/output Capture mode signal port
7	PT2.2/PWM0/PFD	PT2.2 PWM0 PFD	I/O O O	C C C	Digital input/output PWM output port PFD output port
8	VDDA		P	P	Regulator output Analog circuit voltage source
9	ACM		P	P	Internal analog circuit grounding pin
10	AI0/PT4.0	AI0 PT4.0	A I	A C	Analog input channel Digital input
11	AI1/PT4.1	AI1 PT4.1	A I	A C	Analog input channel Digital input
12	AI5/PT4.5	AI5 PT4.5	A I	A C	Analog input channel Digital input
13	VSS		P	P	Chip operation power source grounding pin
14	AI6/PT4.6	AI6 PT4.6	A I	A C	Analog input channel Digital input
15	RST/VPP	RST VPP	I P	S P	Reset the chip EPROM read/write power source
16	PT1.1/INT1/PSCK/TST	PT1.1 INT1 PSCK TST	I I I I	S S S S	Digital input Interrupt source, INT1 PSCK port of OTP read/write Test mode enable input (invalid)

Table 2-3 Pin Definition and Function Description

# HY11P41

Embedded 24-Bit  $\Sigma$ ADC  
8-Bit RISC-like Mixed Signal Microcontroller

## 2.7. Package marker information

### 2.7.1. SSOP16 package

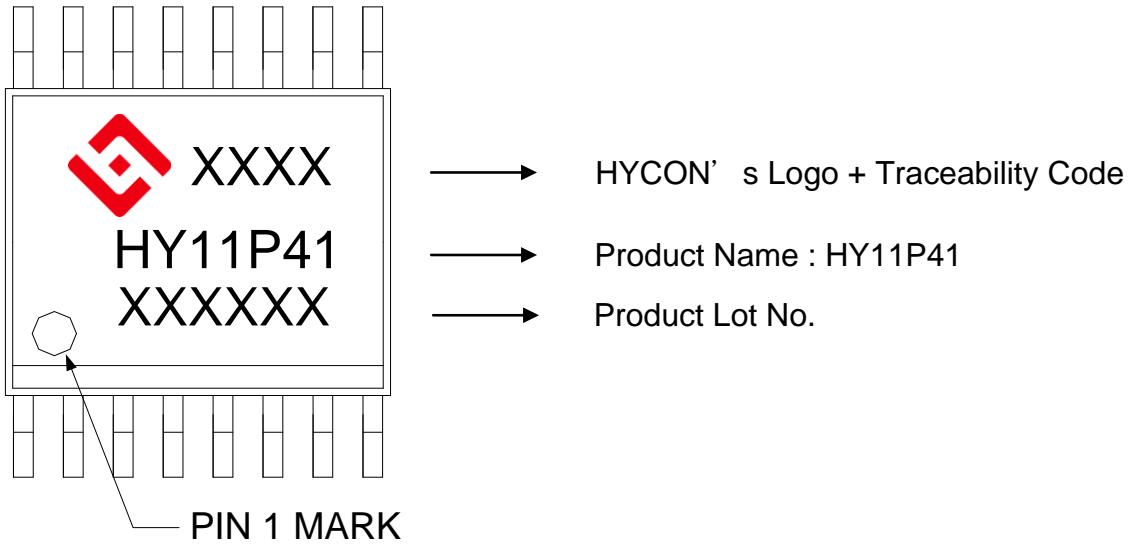

### 2.7.2. SOP16 package

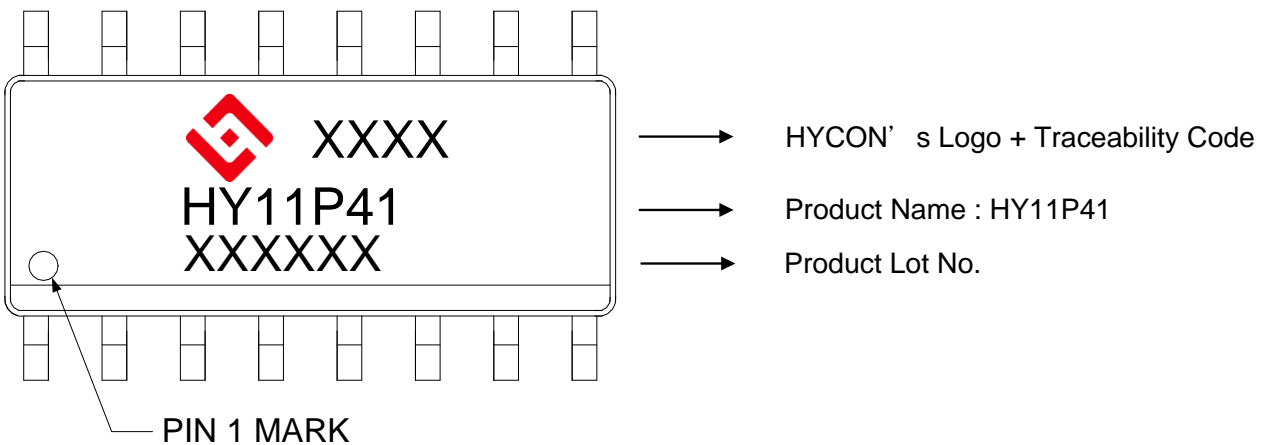

# HY11P41

Embedded 24-Bit  $\Sigma\Delta$ ADC

8-Bit RISC-like Mixed Signal Microcontroller

## 2.7.3. QFN16 package

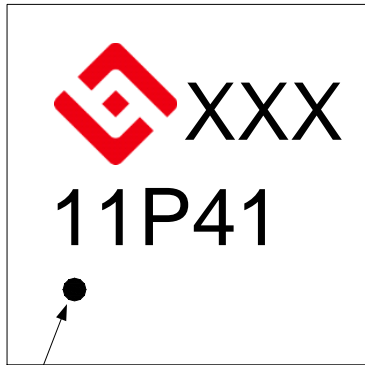

→ HYCON' s Logo + Traceability Code

→ Product Name : HY11P41

→ LASER MARK for PIN 1

# HY11P41

Embedded 24-Bit  $\Sigma\Delta$ ADC  
8-Bit RISC-like Mixed Signal Microcontroller

## 3. Application Circuit

### 3.1. Bridge Sensor I

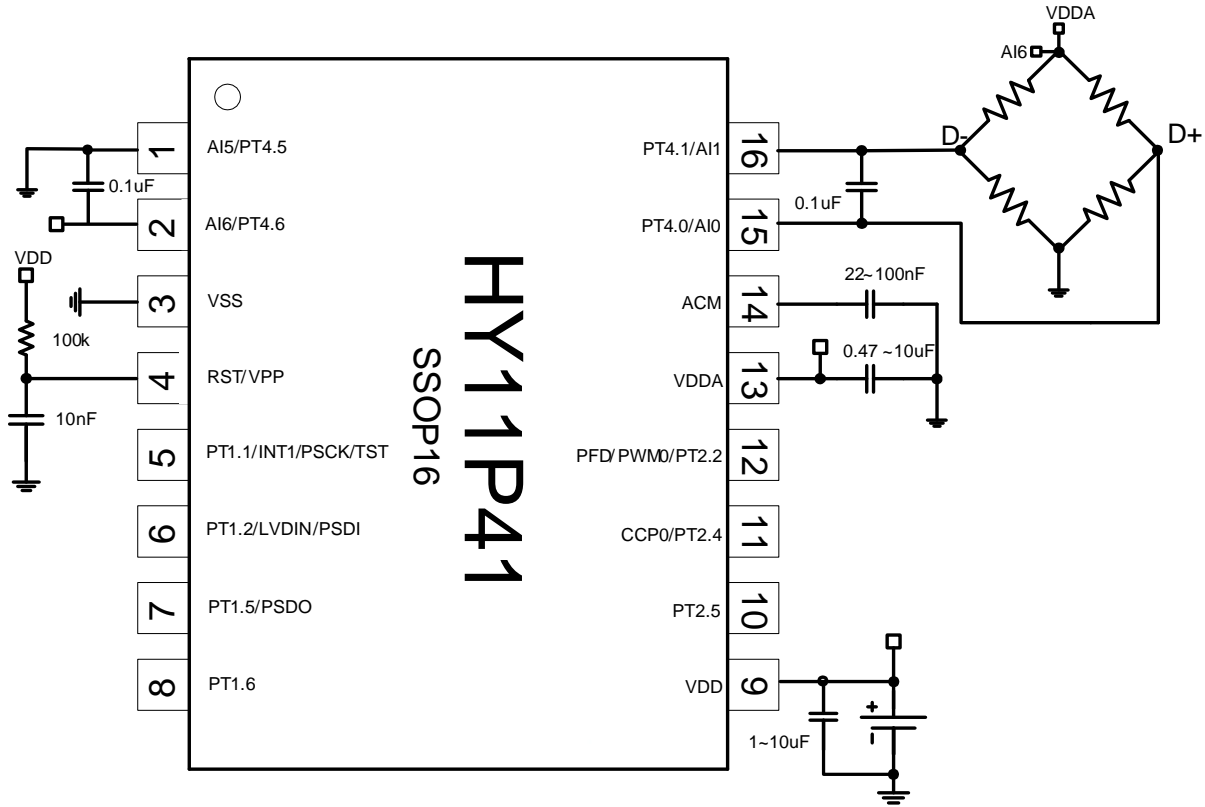

Figure 3-1 Application Circuit for Bridge Sensors

Note 1: DCSET[2:0] can conduct bias adjustment of Load Cell zero point voltage address

Note 2: BIE function can be used to save calibration parameters.

# HY11P41

Embedded 24-Bit  $\Sigma\Delta$ ADC  
8-Bit RISC-like Mixed Signal Microcontroller



## 3.2. Bridge Sensor II

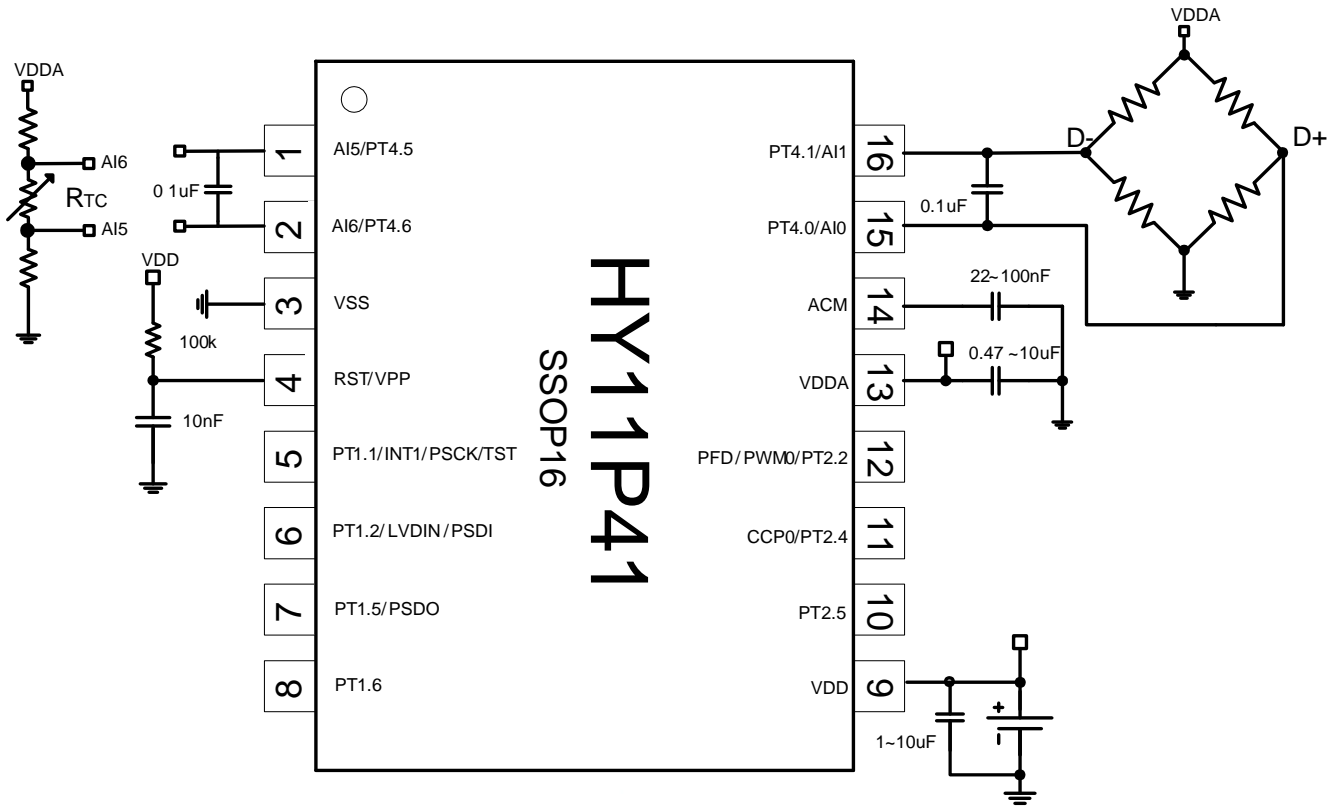

Figure 3-2 Application Circuit of Temperature Compensation Bridge Sensor

Note 1: Using external reference voltage to design temperature compensation resistor NTC basic circuit

Note 2: DCSET[2:0] can conduct bias adjustment of Load Cell zero point voltage address

Note 3: BIE function can be used to save calibration parameters.

# HY11P41

Embedded 24-Bit  $\Sigma\Delta$ ADC  
8-Bit RISC-like Mixed Signal Microcontroller

### 3.3. 4-20mA Two-Wire Current Panel Meter

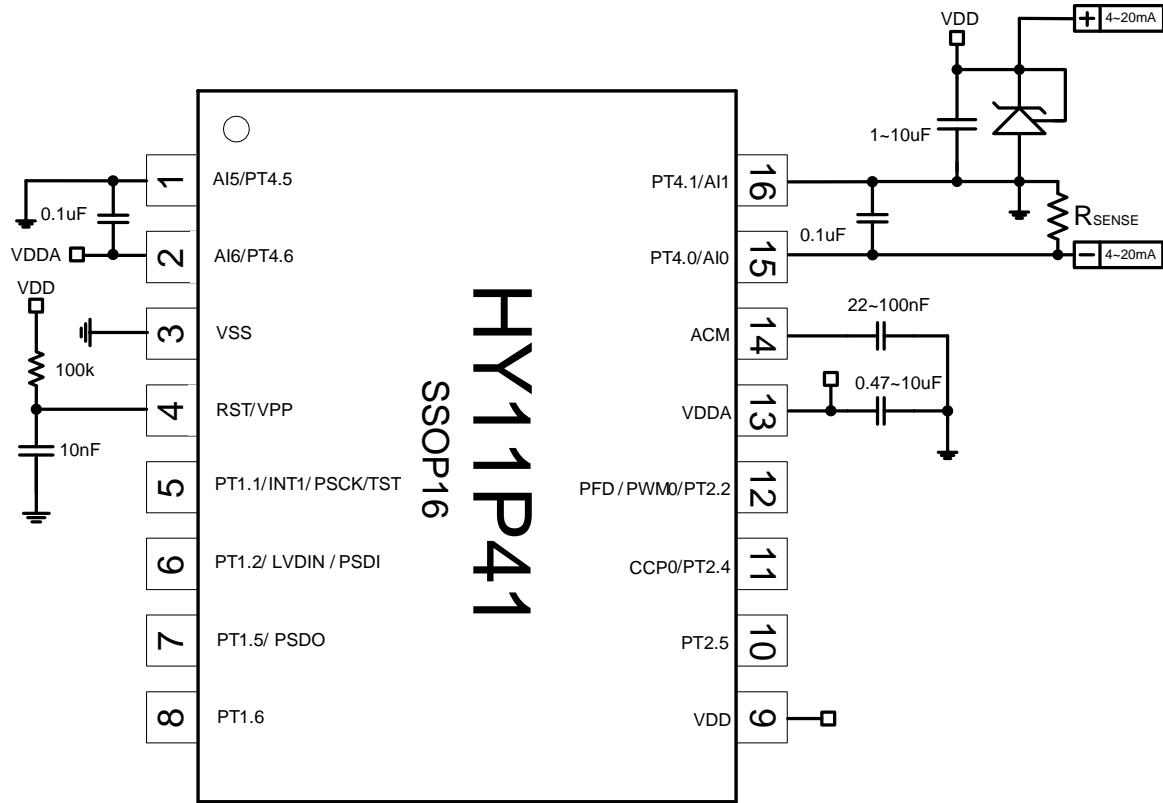

Figure 3-3 4-20mA Panel Meter that Unneeded to Connect External Power Supply

Note 1: DCSET[2:0] can carry out bias adjustment of Load Cell zero point voltage address

Note 2: BIE function can be used to save calibration parameters.

# HY11P41

Embedded 24-Bit  $\Sigma\Delta$ ADC  
8-Bit RISC-like Mixed Signal Microcontroller

## 4. Function Outline

### 4.1. Internal Block Diagram

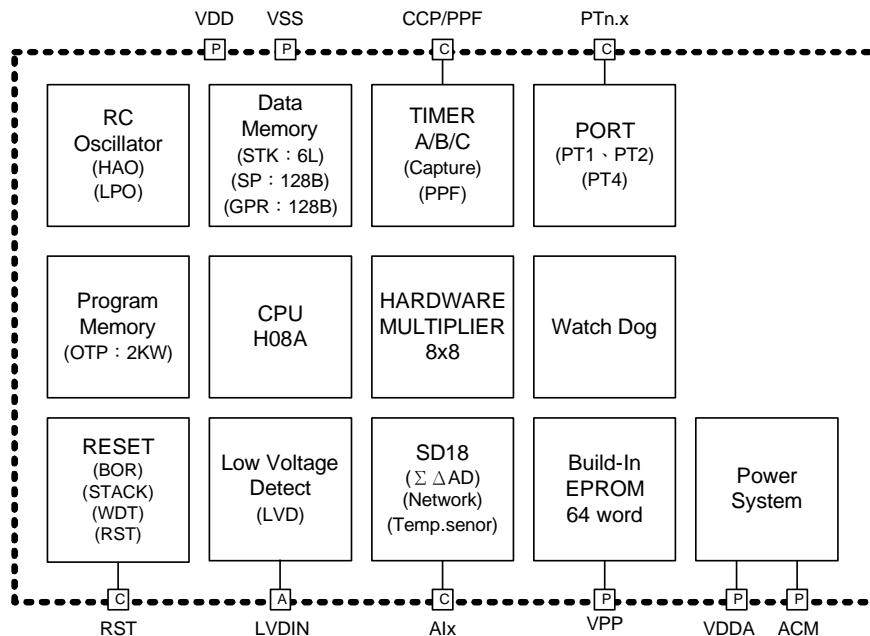

□ Power Pad □ Digital Pad □ Analog Pad □ Common I/O Pad

Figure 4-1 HY11P41 Internal Block Diagram

### 4.2. Related Description and Supporting Documents

#### IC Function Related Operating Instruction

DS-HY11P41	HY11P41 Data Sheet
UG-HY11S14	HY11P Series Users' Manual
APD-CORE002-Vxx	H08A Instruction Description

#### Development Tool Related Operating Instruction

APD-HYIDE006-Vxx	HY11xxx Series Development Tool Software Instruction Manual
APD-HYIDE005-Vxx	HY11xxx Series Development Tool Hardware Instruction Manual
APD-OTP001-Vxx	OTP Products Programming Pin Manual Product

#### Production Related Operating Instruction

APD-HYIDE004-Vxx	HY1xxxx Series Production Line Specialized Programmer Manual
BDI-HY11P41-Vxx	HY11P41 Individual Product Die Bonding Information



**4.3. SD18 Network**

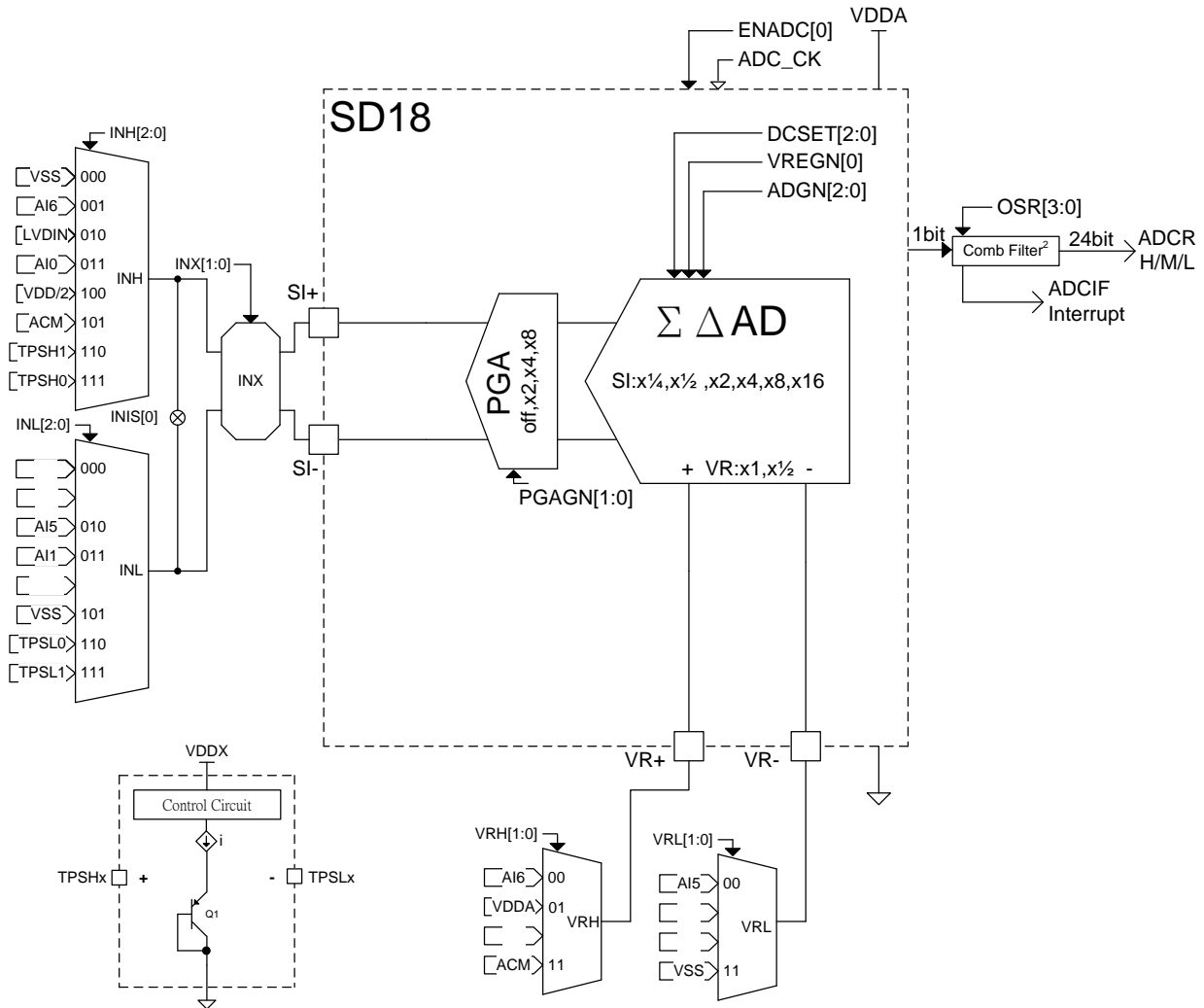

**Figure 4-2 SD18 Network**

Note1: If ADC reference voltage end used AI6-AI5 network to connect external VDDA-VSS power, higher stability would be achieved.

Note2: When using development kit (HY11S14-DK02) for emulation, users need to connect AI8 analog network to VDDA power in order to achieve VRH input as VDDA power source under VRH[1:0]=01b configuration. Connecting AI2 analog network to VSS power to achieve INH input as VSS power source under INH[2:0]=000b configuration. Connecting AI4 analog network to PT1.2 pin (LVDIN) to achieve INH input as LVDIN input source under INH[2:0]=010b configuration.

Note3: Users can connect HY11P41 AD Net Board (PCB No.: T10009-2) to Analog Port: JP3 of development kit (HY11S14-DK02) as to accomplish power configuration of AI8 and AI2 analog network.

# HY11P41

## Embedded 24-Bit ΣΔADC 8-Bit RISC-like Mixed Signal Microcontroller



### 5. Register List

"u"no use, "r"read/write, "w"write, "r"read, "r0"only read 0, "r1"only read 1, "w0"only write 0, "w1"only write 1												
"x"unimplemented bit, "x"unknown, "u"unchanged, "d"depends on condition												
Address	File Name	Bit7	Bit6	Bit5	Bit4	Bit3	Bit2	Bit1	Bit0	A-RESET	i-RESET	R/W
00H	INDF0	Contents of FSR0 to address data memory value of FSR0 not changed								N/A	N/A	*****
01H	POINC0	Contents of FSR0 to address data memory value of FSR0 post-incremented								N/A	N/A	*****
02H	PODEC0	Contents of FSR0 to address data memory value of FSR0 post-decremented								N/A	N/A	*****
03H	PRINC0	Contents of FSR0 to address data memory value of FSR0 pre-incremented								N/A	N/A	*****
04H	PLUSW0	Contents of FSR0 to address data memory value of FSR0 offset by W								N/A	N/A	*****
05H	INDF1	Contents of FSR1 to address data memory value of FSR0 not changed								N/A	N/A	*****
06H	POINC1	Contents of FSR1 to address data memory value of FSR0 post-incremented								N/A	N/A	*****
07H	PODEC1	Contents of FSR1 to address data memory value of FSR0 post-decremented								N/A	N/A	*****
08H	PRINC1	Contents of FSR1 to address data memory value of FSR0 pre-incremented								N/A	N/A	*****
09H	PLUSW1	Contents of FSR1 to address data memory value of FSR0 offset by W								N/A	N/A	*****
0FH	FSR0H	FSR0[8]								....x	....u	*****
10H	FSR0L	Indirect Data Memory Address Pointer 0 Low Byte,FSR0[7:0]								xxxx xxxx	uuuu uuuu	*****
11H	FSR1H	FSR1[8]								....x	....u	*****
12H	FSR1L	Indirect Data Memory Address Pointer 1 Low Byte,FSR1[7:0]								xxxx xxxx	uuuu uuuu	*****
16H	TOSH	TOS[10] TOS[9] TOS[8]								....000	....000	*****
17H	TOSL	Top-of-Stack Low Byte (TOS<7:0>)								0000 0000	0000 0000	*****
18H	STKPTR	STKFL	STKUN	STKOV	STKPR[2:0]			000 .000	000 .000	r,rw0,rw0,-,r,r,r		
1AH	PCLATH	PC[10] PC[9] PC[8]								....000	....000	*****
1BH	PCLATL	PC Low Byte for PC<7:0>								0000 0000	0000 0000	*****
1DH	TBLPTRH	TBLPTR[10] TBLPTR[9] TBLPTR[8]								....000	....000	*****
1EH	TBLPTRL	Program Memory Table Pointer Low Byte (TBLPTR<7:0>)								0000 0000	0000 0000	*****
1FH	TBLDH	Program Memory Table Latch High Byte								0000 0000	0000 0000	*****
20H	TBLDL	Program Memory Table Latch Low Byte								0000 0000	0000 0000	*****
21H	PRODH	Product Register of Multiply High Byte								xxxx xxxx	uuuu uuuu	r,r,r,r,r,r,r,r
22H	PRODL	Product Register of Multiply Low Byte								xxxx xxxx	uuuu uuuu	r,r,r,r,r,r,r,r
23H	INTE1	GIE	ADGIE	TMCIE	TMBIE	TMAIE	WDTIE	E1IE	CCP0IE	0000 000.	000. 000.	*****
24H	INTE2	Working Register								....0	....0	*****
26H	INTF1	ADCIF	TMCIF	TMBIF	TMAIF	WDTIF	E1IF	CCP0IF	.000 000.	.00. 000.	*****	
27H	INTF2	Working Register								....0	....0	*****
29H	WREG	Working Register								xxxx xxxx	uuuu uuuu	*****
2AH	BSRCN	BSR[0]								....0	....0	*****
2BH	STATUS	C DC N OV Z								...x xxxx	...u uuuu	*****
2CH	PSTATUS	PD	TO	IDLEB	BOR	SKERR	rw0,rw0,rw0,rw0,-,rw0,-,-					
2DH	LVDCN	LVDFG	LVD	LVDON	VLDX[3:0]			.000 0000	.000 uuuu	-,r,r,r,*,*,*,*		
30H	PWRCN	ENVDDA	VDDAX[1:0]	ENACM	ENHAO			0000 ....	0000 ....	*****		
31H	MCKCN1	ADCS[2:0]		ADCK	ENHAO			0000 ...1	0000 ...1	*****		
32H	MCKCN2	HSS[1:0]			CPUCK[1:0]			.... 0000	.... 0000	*****		
33H	MCKCN3	PERCK			CPUCK[1:0]			.... 0...	.... 0...	*****		
39H	ADCRH	ADC conversion memory HighByte								xxxx xxxx	uuuu uuuu	r,r,r,r,r,r,r,r
3AH	ADCRM	ADC conversion memory Middle Byte								xxxx xxxx	uuuu uuuu	r,r,r,r,r,r,r,r
3BH	ADCRL	ADC conversion memory Low Byte								xxxx xxxx	uuuu uuuu	r,r,r,r,r,r,r,r
3CH	ADCCN1	ENADC	ENHIGN	ENCHP	PGAGN[1:0]	ADGN[2:0]			0000 0000	0000 0000	*****	
3DH	ADCCN2	VREGN			DCSET[2:0]			.... 0000	.... 0000	*****		
3EH	ADCCN3	OSR[2:0]		OSR[3]			000 .0.	000 .0.	*****			
3FH	AINET1	INH[2:0]		INL[2:0]		INIS			0000 000.	0000 000.	*****	
40H	AINET2	VRH[1:0]		INX[1:0]		VRL[1:0]			.000 000.	.000 000.	*****	
41H	TMACN	ENTMA	TMACK	TMAS[1:0]	ENWDT	WDTS[2:0]			0000 0000	0000 0000	***** w1,*,*,*	
42H	TMAR	TimerA data register								xxxx xxxx	uuuu uuuu	r,r,r,r,r,r,r,r
43H	TMCBN	ENTMB	TMACK	TMBS[1:0]	TMBSYC	TMBR2R			0000 00.	0000 00.	*****	
44H	TMBRH	TimerB High Byte data register								xxxx xxxx	uuuu uuuu	*****
45H	TMBRL	TimerB Low Byte data register								xxxx xxxx	uuuu uuuu	*****
46H	TMCCN	ENTMC	TMCK[1:0]	TMCS1[2:0]		TMCS0[1:0]			0000 0000	0000 0000	*****	
47H	PRC	TimerC programmable register								1111 1111	1111 1111	*****
48H	TMCR	TimerC register								0000 0000	0000 0000	r,r,r,r,r,r,r,r
49H	CCPCN	CCP0M[3:0]								.... 0000	.... 0000	*****
4AH	CCP0RH	CCP0 High Byte data register								xxxx xxxx	uuuu uuuu	*****
4BH	CCP0L	CCP0 Low Byte data register								xxxx xxxx	uuuu uuuu	*****
4FH	PWMCN	ENPWM	ENPFD	PWMRL[1:0]			PWMRL[1:0]			0000 ....	0000 ....	*****
51H	PWMR	PWM MSB Byte register								xxxx xxxx	uuuu uuuu	*****
6AH	PT4	PT4.6	PT4.5	PT4.1			PT4.0			.xx .xx	.uu .uu	-,r,r,-,r,r,-,r,r
6BH	PT4DA	DA4.6	DA4.5	DA4.1			DA4.0			.11 .11	.11 .11	-,r,r,-,r,r,-,r,r
6CH	PT4PU	PU4.6	PU4.5	PU4.1			PU4.0			.00 .00	.00 .00	-,r,r,-,r,r,-,r,r
6DH	PT1	PT1.6	PT1.5	PT1.2			PT1.1			.xx .xx	.uu .uu	-,r,r,-,r,r,-,r,r
6EH	TRISC1	TC1.6	TC1.5	TC1.2			TC1.1			.00 ....	.00 ....	-,r,r,-,r,r,-,r,r
6FH	PT1DA	DA1.2								.... 0.	.... 0.	-,r,r,-,r,r,-,r,r
70H	PT1PU	PU1.6	PU1.5	PU1.2			PU1.1			.00 .00.	.00 .00.	-,r,r,-,r,r,-,r,r
71H	PT1M1	INTEG1[1:0]								.... 00.	.... 00.	*****
72H	PT1M2	PM1.6[0]			PM1.5[0]			...0 .0.	...0 .0.	*****		
74H	PT2	PT2.5		PT2.4		PT2.2			..xx .x.	..uu .u.	-,r,r,-,r,r,-,r,r	
75H	TRISC2	TC2.5		TC2.4		TC2.2			.00 .0.	.00 .0.	-,r,r,-,r,r,-,r,r	
77H	PT2PU	PU2.5		PU2.4		PU2.2			.00 .0.	.00 .0.	-,r,r,-,r,r,-,r,r	
78H	PT2M1	PM2.2[1]		PM2.2[0]		PM2.2[0]			.00 ....	.00 ....	*****	
80H ~ FFH	GPR0	General Purpose Register as 128Byte								xxxx xxxx	uuuu uuuu	*****
195H	BICTRL	VPP_HIGH								1000 d000	1000 d000	***** r0,*,*
196H	BIEPTRH	BIEWR								0000 0000	0000 0000	w0,w0,w0,w0,w0,w0,w0,w0
197H	BIEPTRL	0	0	BIE_ADDR[5:0]			BIE_ADDR[5:0]			0000 0000	0000 0000	w0,w0,*,*,*,*,*
198H	BIEDH	BIE_DATA[15:8]								xxxx xxxx	xxxx xxxx	*****
199H	BIEDL	BIE_DATA[7:0]								xxxx xxxx	xxxx xxxx	*****

Table 5-1 HY11P41 Register List

# HY11P41

Embedded 24-Bit  $\Sigma\Delta$ ADC  
8-Bit RISC-like Mixed Signal Microcontroller



## 6. Electrical Characteristics

Absolute maximum ratings over operating free-air temperature (unless otherwise noted)

Voltage applied at $V_{DD}$ to $V_{SS}$ .....	-0.2 V to 4.0 V
Voltage applied to any pin .....	-0.2 V to $V_{DD} + 0.3$ V
Voltage applied to RST/VPP pin .....	-0.2 V to 6.9 V
Voltage applied to TST/PT1.1 pin .....	-0.2 V to $V_{DD} + 1$ V
Diode current at any device terminal .....	$\pm 2$ mA
Storage temperature, Tstg: (unprogrammed device) .....	-55°C to 150°C
(programmed device) .....	-40°C to 85°C
Total power dissipation.....	0.5w
Maximum output current sink by any PORT1 to PORT2 I/O pin.....	.25mA

### 6.1. Recommended Operating Conditions

$T_A = -40^\circ\text{C} \sim 85^\circ\text{C}$ , unless otherwise noted

Sym.	Parameter	Test Conditions	Min.	Typ.	Max.	Unit
$V_{DD}$	Supply Voltage	All digital peripherals and CPU	2.2		3.6	V
		Analog peripherals	2.4		3.6	
$V_{SS}$	Supply Voltage		0		0	

## 6.2. Internal RC Oscillator

$T_A = 25^\circ\text{C}$ ,  $V_{DD} = 3.0\text{V}$ , unless otherwise noted

Sym.	Parameter	Test Conditions	Min.	Typ.	Max.	Unit
HAO	High Speed Oscillator frequency	ENHAO[0]=1	1.8	2.0	2.2	MHz
LPO	Low Power Oscillator frequency	$V_{DD}$ supply voltage be enable LPO	22	28	35	KHz

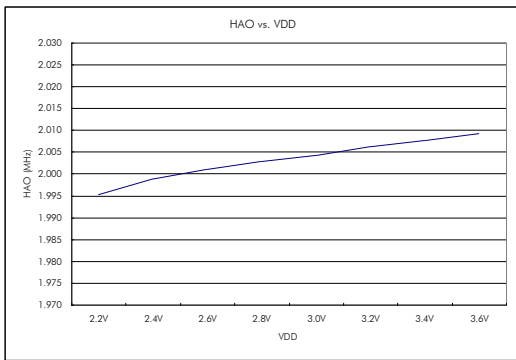

Figure 6.2-1 HAO vs. VDD

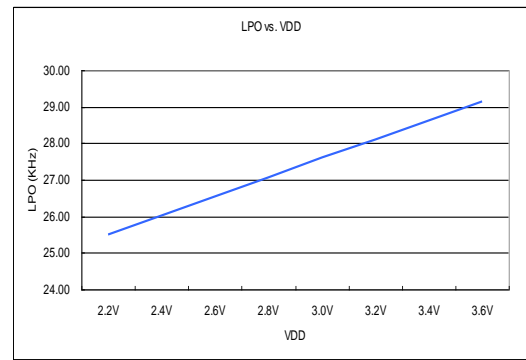

Figure 6.2-2 LPO vs. VDD

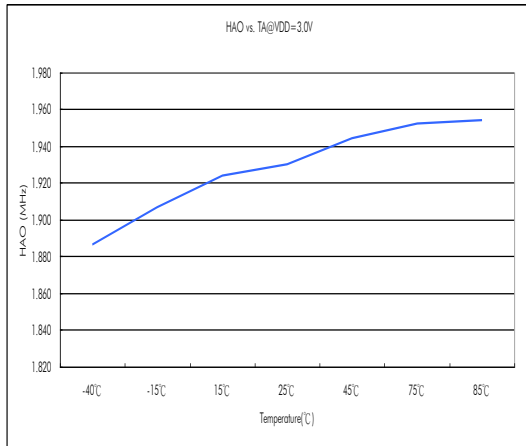

Figure 6.2-3 HAO vs. Temperature

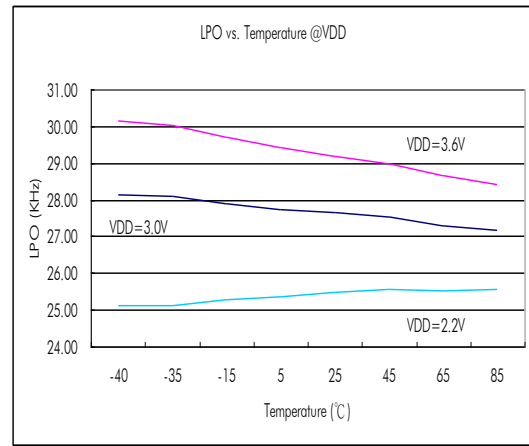

Figure 6.2-4 LPO vs. Temperature

### 6.3. Supply Current into VDD Excluding Peripherals Current

$T_A = 25^\circ\text{C}, V_{DD} = 3.0\text{V}, \text{OSC\_LPO} = 28\text{KHz}$ , unless otherwise noted

Sym.	Parameter	Test Conditions	Min.	Typ.	Max.	Unit
$I_{AM2}$	Active mode 2	OSC_CY = off, OSC_HAO = 2MHz, CPU_CK = 2MHz		0.32	0.55	mA
$I_{AM3}$	Active mode 3	OSC_CY = off, OSC_HAO = 2MHz, CPU_CK = 1MHz		0.18	0.3	mA
$I_{LP2}$	Low Power 2	OSC_CY = off, OSC_HAO = off, CPU_CK = LPO, Idle state		1.65	3	$\mu\text{A}$
$I_{LP3}$	Low Power 3	OSC_CY = off, OSC_HAO = off, CPU_CK = off, Sleep state		0.65	1.2	$\mu\text{A}$

OSC\_HAO : Internal High Accuracy Oscillator frequency.

CPU\_CK : CPU core work frequency.

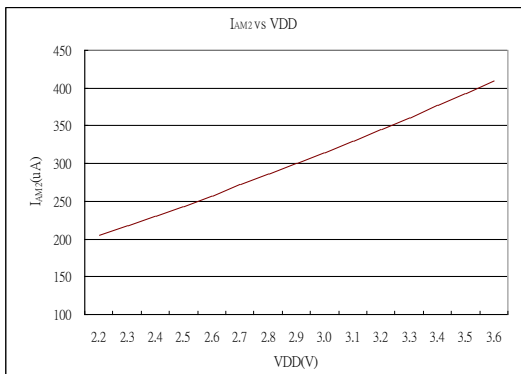

Figure 6.3-1  $I_{AM2}$  vs. VDD

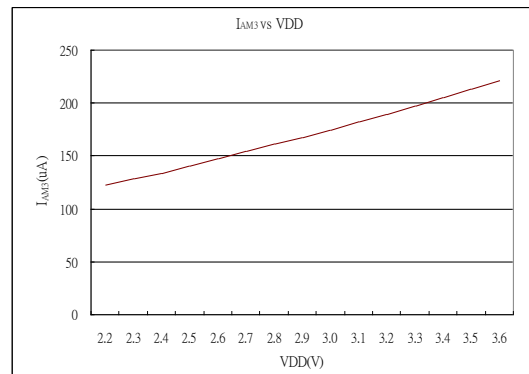

Figure 6.3-2  $I_{AM3}$  vs. VDD

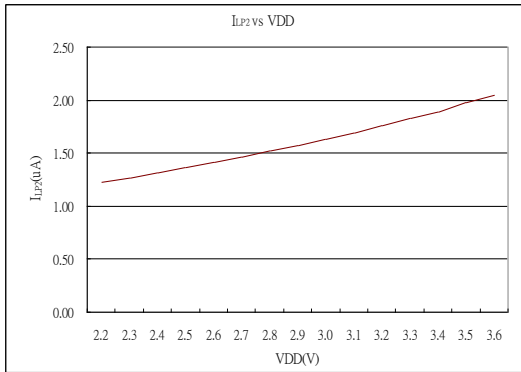

Figure 6.3-3  $I_{LP2}$  vs. VDD

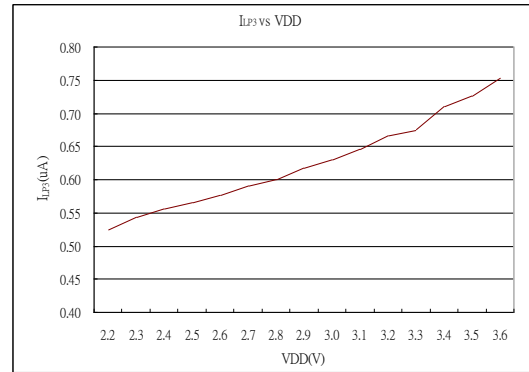

Figure 6.3-4  $I_{LP3}$  vs. VDD

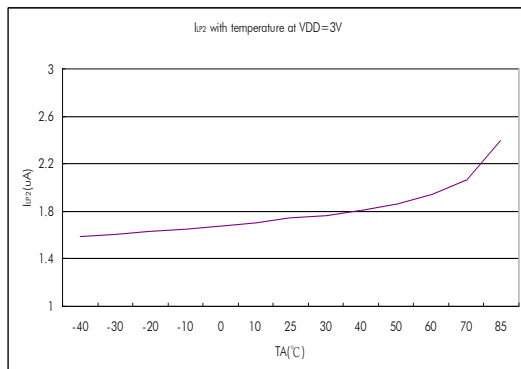

Figure 6.3-5  $I_{LP2}$  vs. Temperature

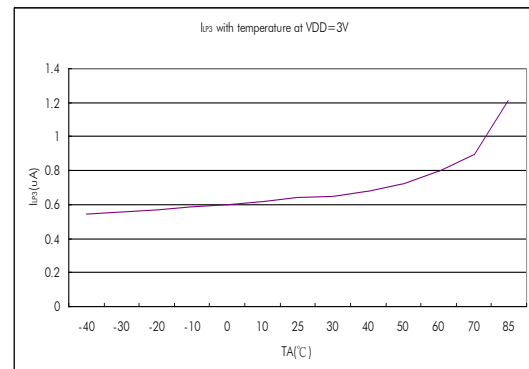

Figure 6.3-6  $I_{LP3}$  vs. Temperature

## 6.4. Port1~4

$T_A = 25^\circ\text{C}, V_{DD} = 3.0\text{V}$ , unless otherwise noted

Sym.	Parameter	Test Conditions	Min.	Typ.	Max.	Unit
<b>Input voltage and Schmitt trigger and leakage current and timing</b>						
$V_{IH}$	High-Level input voltage		$0.7 \cdot V_{DD}$		$V_{DD}$	V
$V_{IL}$	Low-Level input voltage		VSS		$0.3 \cdot V_{DD}$	
$V_{hys}$	Input Voltage hysteresis( $V_{IH} - V_{IL}$ )			0.8		V
$I_{LKG}$	Leakage Current				0.1	$\mu\text{A}$
$R_{PU}$	Port pull high resistance			180		$\text{k}\Omega$
<b>Output voltage and current and frequency</b>						
$V_{OH}$	High-level output voltage	$I_{OH} = 10\text{mA}$	$V_{DD} - 0.3$			V
$V_{OL}$	Low-level output voltage	$I_{OL} = -10\text{mA}$			$V_{SS} + 0.3$	

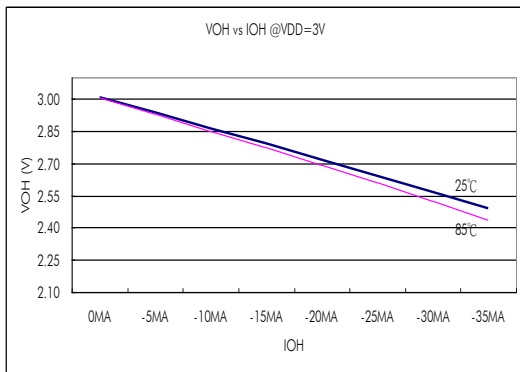

Figure 6.4-1  $V_{OH}$  vs.  $I_{OH}$  @  $V_{DD} = 3.0\text{V}$

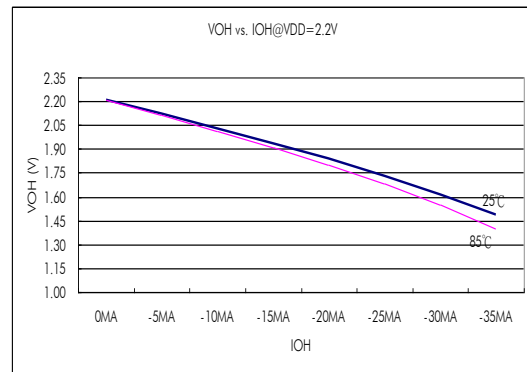

Figure 6.4-2  $V_{OH}$  vs.  $I_{OH}$  @  $V_{DD} = 2.2\text{V}$

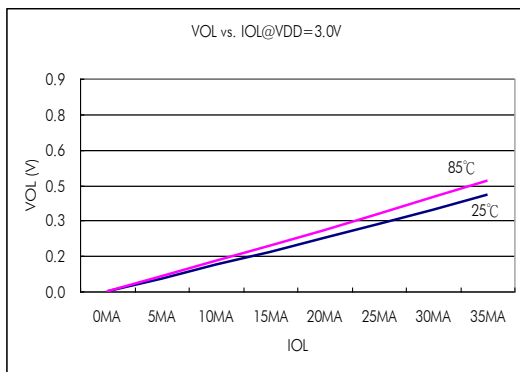

Figure 6.4-3  $V_{OL}$  vs.  $I_{OL}$  @  $V_{DD} = 3.0\text{V}$

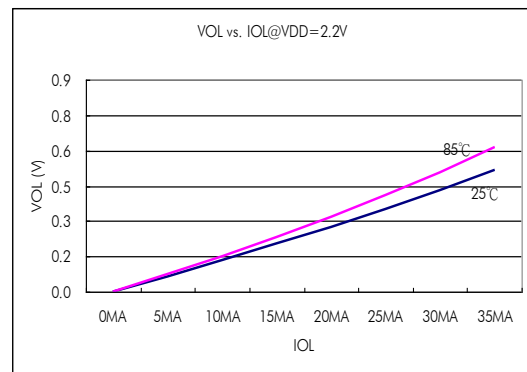

Figure 6.4-4  $V_{OL}$  vs.  $I_{OL}$  @  $V_{DD} = 2.2\text{V}$

# HY11P41

## Embedded 24-Bit $\Sigma\Delta$ ADC 8-Bit RISC-like Mixed Signal Microcontroller



### 6.5. Reset (Brownout, External RST Pin, Low Voltage Detect)

$T_A = 25^\circ\text{C}, V_{DD} = 3.0\text{V}$ , unless otherwise noted

Sym.	Parameter	Test Conditions	Min.	Typ.	Max.	Unit	
BOR	Pulse length needed to accepted reset internally, $t_{d-LVR}$		2			$\mu\text{S}$	
	$V_{DD}$ Start Voltage to accepted reset internally (L $\rightarrow$ H), $V_{LVR}$		1.6	1.85	2.1	V	
	Hysteresis, $V_{HYS-LVR}$		70			mV	
RST	Pulse length needed as RST/VPP pin to accepted reset internally, $t_{d-RST}$		2			$\mu\text{S}$	
	Input Voltage to accepted reset internally		0.9			V	
	Hysteresis, $V_{HYS-RST}$		0.8			V	
LVD	Operation current, $I_{SVS}$			10	15	$\mu\text{A}$	
	External input voltage to compare reference voltage		1.2			V	
	Compare reference voltage temperature drift	$T_A = -40^\circ\text{C} \sim 85^\circ\text{C}$	100			ppm/ $^\circ\text{C}$	
	Detect $V_{DD}$ voltage rang by user option, $V_{SVS} VLDx[3:0]=1110b$		3.3			V	
	Detect $V_{DD}$ voltage rang by user option, $V_{SVS} VLDx[3:0]=1101b$		3.2				
	Detect $V_{DD}$ voltage rang by user option, $V_{SVS} VLDx[3:0]=1100b$		3.1				
	Detect $V_{DD}$ voltage rang by user option, $V_{SVS} VLDx[3:0]=1011b$		3.0				
	Detect $V_{DD}$ voltage rang by user option, $V_{SVS} VLDx[3:0]=1010b$		2.9				
	Detect $V_{DD}$ voltage rang by user option, $V_{SVS} VLDx[3:0]=1001b$		2.8				
	Detect $V_{DD}$ voltage rang by user option, $V_{SVS} VLDx[3:0]=1000b$		2.7				
	Detect $V_{DD}$ voltage rang by user option, $V_{SVS} VLDx[3:0]=0111b$		2.6				
	Detect $V_{DD}$ voltage rang by user option, $V_{SVS} VLDx[3:0]=0110b$		2.5				
	Detect $V_{DD}$ voltage rang by user option, $V_{SVS} VLDx[3:0]=0101b$		2.4				
	Detect $V_{DD}$ voltage rang by user option, $V_{SVS} VLDx[3:0]=0100b$		2.3				
	Detect $V_{DD}$ voltage rang by user option, $V_{SVS} VLDx[3:0]=0011b$		2.2				
	Detect $V_{DD}$ voltage rang by user option, $V_{SVS} VLDx[3:0]=0010b$		2.1				
	Detect $V_{DD}$ voltage rang by user option, $V_{SVS} VLDx[3:0]=0001b$		2.0				
BOR : Brownout Reset LVR : Low Voltage Reset of BOR LVD : Low Voltage Detect RST : External Reset pin							

# HY11P41

## Embedded 24-Bit $\Sigma\Delta$ ADC

### 8-Bit RISC-like Mixed Signal Microcontroller

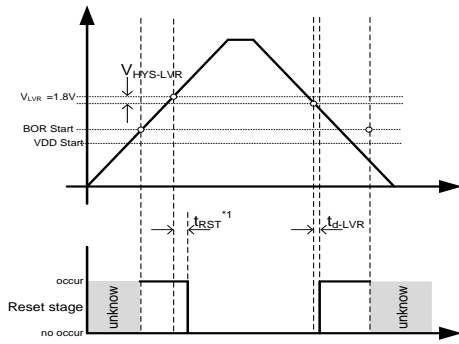

Figure 6.5-1 BOR Reset Diagram

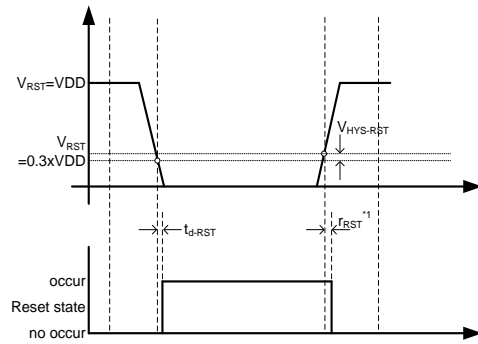

Figure 6.5-2 RST Reset Diagram

\*1  $t_{RST}$  : Please see BOR Introduce of HY11Pxx series User's Guide (UG-HY11S14-Vxx).

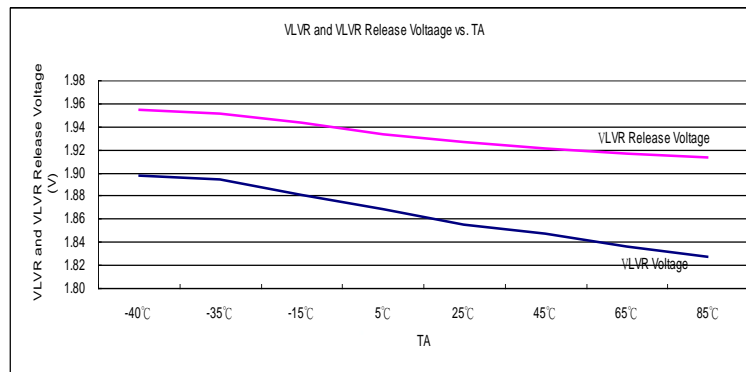

Figure 6.5-3 LVR vs. Temperature



# HY11P41

## Embedded 24-Bit $\Sigma\Delta$ ADC 8-Bit RISC-like Mixed Signal Microcontroller

### 6.6. Power System

$T_A = 25^\circ\text{C}, V_{DD} = 3.0\text{V}$ , unless otherwise noted

Sym.	Parameter	Test Conditions		Min.	Typ.	Max.	Unit
VDDA	VDDA operation current, $I_{VDDA}$	$I_L = 0\text{mA}$	VDDAX[1:0]=00b	22			$\mu\text{A}$
	Select VDDA output voltage	$I_L = 0.1\text{mA}$ , $V_{DD} \geq V_{DDA} + 0.2\text{V}$	VDDAX[1:0]=00b	3.4			V
			VDDAX[1:0]=01b	3.0			V
			VDDAX[1:0]=10b	2.6			V
			VDDAX[1:0]=11b	2.4			V
	Dropout voltage	$I_L = 10\text{mA}$	VDDAX[1:0]=00b	135			mV
			VDDAX[1:0]=01b	150			mV
			VDDAX[1:0]=10b	165			mV
VDDAX[1:0]=11b			180			mV	
Temperature drift	VDDAX[1:0]=11b	$T_A = -40^\circ\text{C} \sim 85^\circ\text{C}$	50			ppm/ $^\circ\text{C}$	
$V_{DD}$ Voltage drift	$I_L = 0.1\text{mA}$	$V_{DD} = 2.5\text{V} \sim 3.6\text{V}$	$\pm 0.2$			%/V	
ACM	ACM operation current, $I_{ACM}$	$I_L = 0\text{mA}$		20			$\mu\text{A}$
	Output voltage, $V_{ACM}$	ENACM[0]=1, *1	$I_L = 0\mu\text{A}$	1.0			V
	Output voltage with Load		$I_L = \pm 200\mu\text{A}$	0.98	1.02	$V_{ACM}$	
	Output voltage, $V_{ACM}$	ENACM[0]=1, *2	$I_L = 0\mu\text{A}$	1.2			V
	Output voltage with Load		$I_L = \pm 200\mu\text{A}$	0.98	1.02	$V_{ACM}$	
	Temperature drift	ENACM[0]=1,	$T_A = -40^\circ\text{C} \sim 85^\circ\text{C}$	50			ppm/ $^\circ\text{C}$
	VDDA Voltage drift	$I_L = 10\mu\text{A}$		100			$\mu\text{V}/\text{V}$

VDDA : Adjust Voltage Regulator  
ACM : Analog Common Mode Voltage

\*1:  $V_{ACM} = 1.0\text{V}$  is just at A/D differential voltage reference < 1.4V ( if delta VR:  $(V_{DDA}-V_{SS})/2$  )  
\*2:  $V_{ACM} = 1.2\text{V}$  is just at A/D differential voltage reference > 1.4V ( if delta VR:  $(V_{DDA}-V_{SS})/2$  )

# HY11P41

## Embedded 24-Bit $\Sigma\Delta$ ADC

### 8-Bit RISC-like Mixed Signal Microcontroller

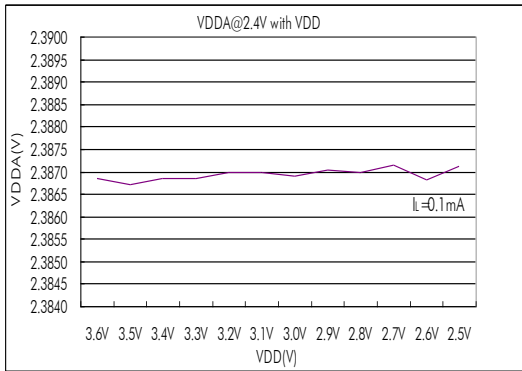

Figure 6.6-1 VDDA  $I_L=0.1\text{mA}$  vs. VDD

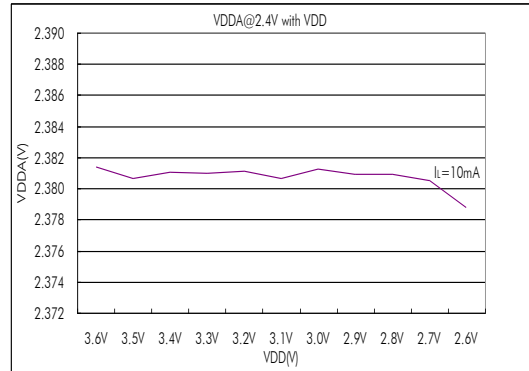

Figure 6.6-2 VDDA  $I_L=10\text{mA}$  vs. VDD

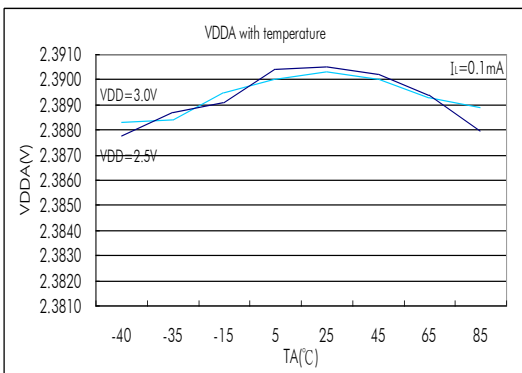

Figure 6.6-3 VDDA  $I_L=0.1\text{mA}$  vs. Temperature

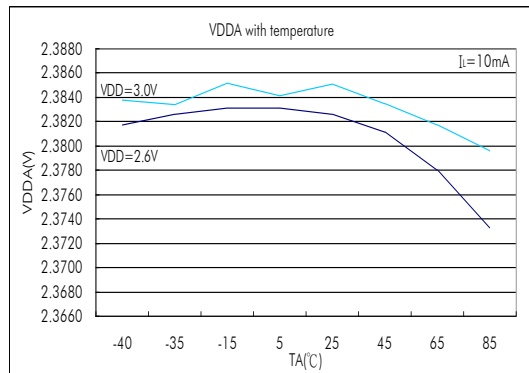

Figure 6.6-4 VDDA  $I_L=10\text{mA}$  vs. Temperature

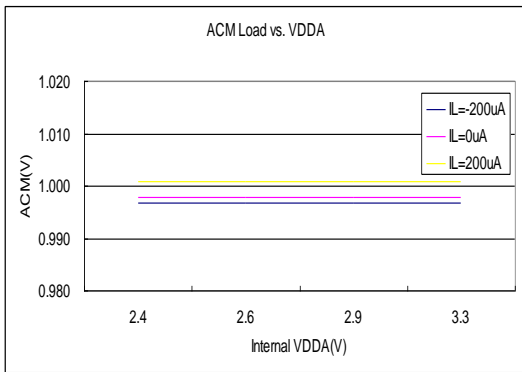

Figure 6.6-5 ACM Load vs. VDDA (a)

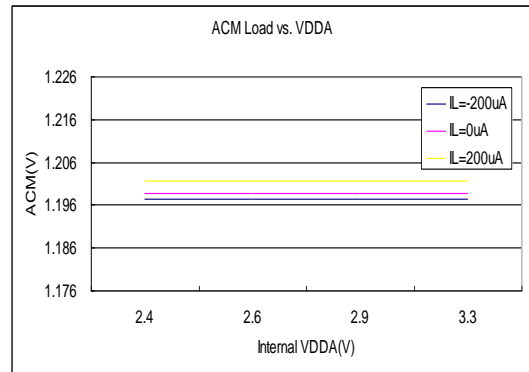

Figure 6.6-5 ACM Load vs. VDDA (b)

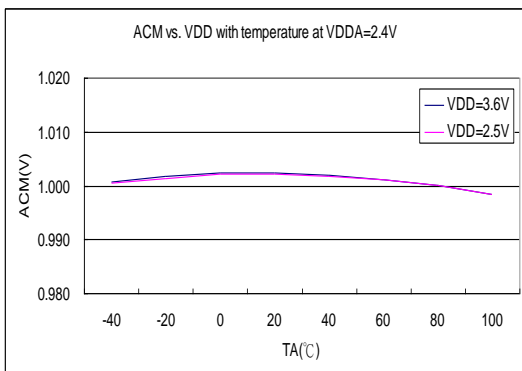

Figure 6.6-6 ACM vs. Temperature (a)

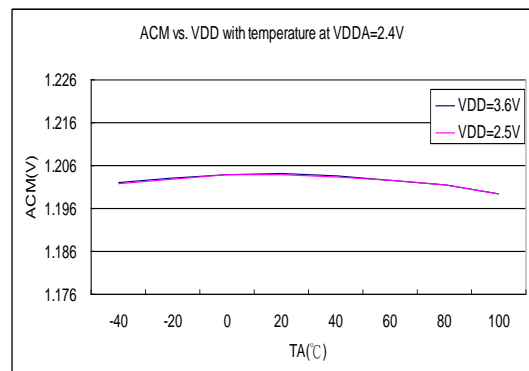

Figure 6.6-6 ACM vs. Temperature (b)

# HY11P41

## Embedded 24-Bit $\Sigma\Delta$ ADC 8-Bit RISC-like Mixed Signal Microcontroller



### 6.7. SD18, Power Supply and Recommended Operating Conditions

$T_A = 25^\circ\text{C}, V_{DD} = 3.0\text{V}, V_{DDA}=2.4\text{V}$ , unless otherwise noted

Sym.	Parameter	Test Conditions		Min.	Typ.	Max.	Unit
$V_{SD18}$	Supply Voltage at VDDA	ENVDDA[0]=0		2.4		3.6	V
$f_{SD18}$	Modulator sample frequency, ADC_CK			25	250	300	KHz
	Over Sample Ratio, OSR			256		32768	
$I_{SD18}$	Operation supply current without PGA	ENADC[0]=1	GAIN =4, ADC_CK=250KHz		120		$\mu\text{A}$
*1, OSR=128, setting by ADCCN3[ OSR[3] ] bit. OSR[3:0]=1010, OSR=128; OSR[3:0]=0xxx, OSR=256 ~ 32768							

#### 6.7.1. PGA, Power Supply and Recommended Operating Conditions

$T_A = 25^\circ\text{C}, V_{DD} = 3.0\text{V}, V_{DDA}=2.4\text{V}$ , unless otherwise noted

Sym.	Parameter	Test Conditions		Min.	Typ.	Max.	Unit
$V_{PGA}$	Supply Voltage at VDDA	ENVDDA[0]=0		2.4		3.6	V
$I_{PGA}$	Operation supply current	PGAGN[1:0]=<01>or<1x>			320		$\mu\text{A}$
$G_{PGA}$	Gain temperature drift	$T_A = -40^\circ\text{C} \sim 85^\circ\text{C}$	GAIN=128		5		ppm/ $^\circ\text{C}$

#### 6.7.2. SD18, Performance II ( $f_{SD18}=250\text{KHz}$ )

$T_A = 25^\circ\text{C}, V_{DD} = 3.0\text{V}, V_{DDA}=2.9\text{V}, V_{VR}=1.0\text{V}, \text{GAIN}=1$  without PGA, unless otherwise noted

Sym.	Parameter	Test Conditions		Min.	Typ.	Max.	unit
INL	Integral Nonlinearity(INL)	$V_{DDA}=2.4\text{V}, V_{VR}=1.0\text{V}, \Delta\text{SI}=\pm 450\text{mV}$			$\pm 0.003$	$\pm 0.01$	%FSR
	No Missing Codes <sup>3</sup>	ADC_CK=250KHz, OSR[2:0]=010b		23			Bits
$G_{SD18}$	Temperature drift Gain 1~x16		$T_A = -40^\circ\text{C} \sim 85^\circ\text{C}$		2		ppm/ $^\circ\text{C}$
$E_{OS}$	Offset error of Full Scale Rang input voltage range with Chopper without PGA	$\Delta\text{AI}=0\text{V}$ $\Delta\text{VR}=0.9\text{V}$ DCSET[2:0]=<000> * $\Delta\text{AI}$ is external short	Gain=2			1	%FSR
	Offset temperature drift with chopper without PGA		GAIN=1		2		$\mu\text{V}/^\circ\text{C}$
			GAIN=2		1		
			GAIN=4		0.5		
			GAIN=16		0.15		
GAIN=128		0.02					

# HY11P41

## Embedded 24-Bit $\Sigma\Delta$ ADC 8-Bit RISC-like Mixed Signal Microcontroller



CM <sub>SD18</sub>	Common-mode rejection	V <sub>CM</sub> =0.7V to 1.7V, V <sub>VR</sub> =1.0V, without PGA	V <sub>SI</sub> =0V, GAIN=1	90	dB
		V <sub>CM</sub> =0.7V to 1.7V, V <sub>VR</sub> =1.0V,	V <sub>SI</sub> =0V, GAIN=16	75	
PSRR	DC power supply rejection	V <sub>D</sub> DA=3.0V, $\Delta$ V <sub>D</sub> DA=±100mV, V <sub>VR</sub> =1.0V, V <sub>SI</sub> =V <sub>SI</sub> =1.2V,	GAIN=1 PGA=off	75	dB
			GAIN=16		

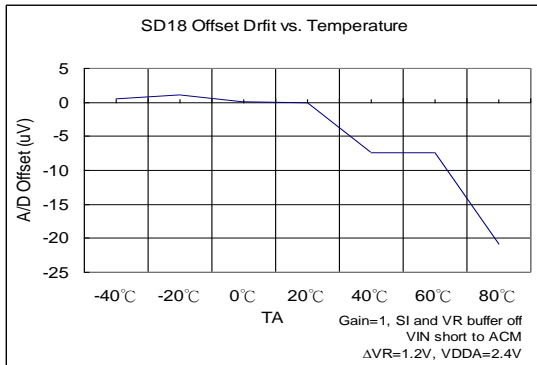

Figure 6.7-1(a) SD18 Offset Temperature Drift

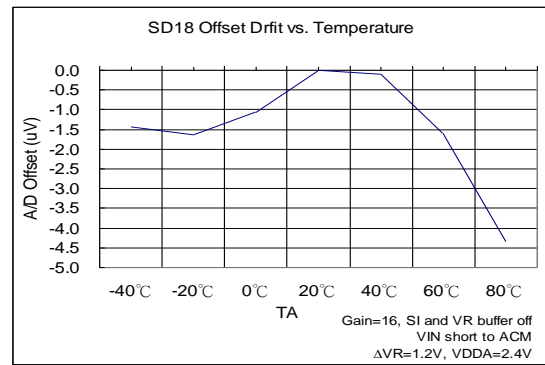

Figure 6.7-1(b) SD18 Offset Temperature Drift

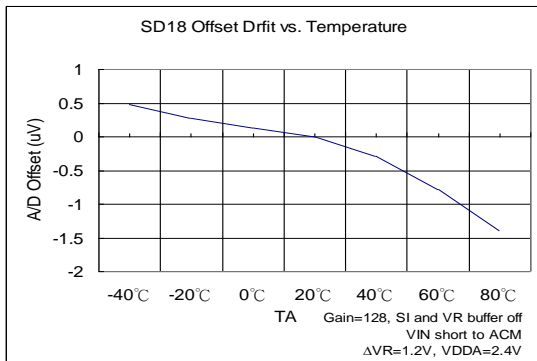

Figure 6.7-1(c) SD18 Offset Temperature Drift

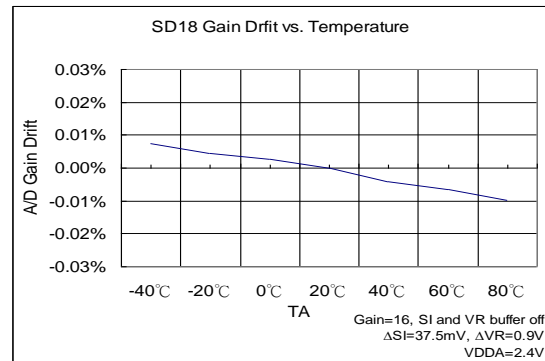

Figure 6.7-2(b) SD18 Gain Drift with Temperature

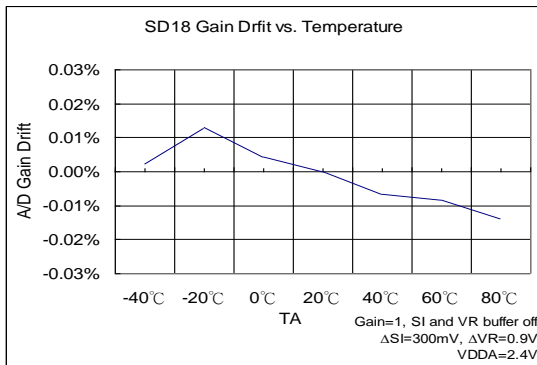

Figure 6.7-2(a) SD18 Gain Drift with Temperature

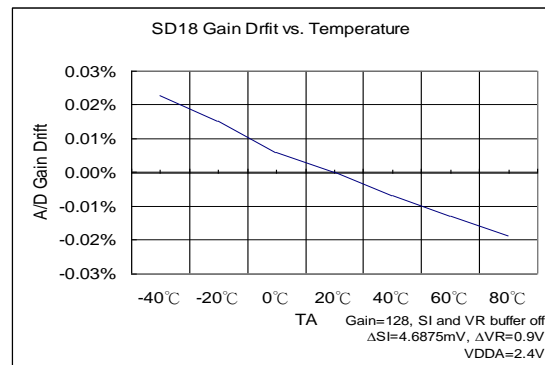

Figure 6.7-2(c) SD18 Gain Drift with Temperature

# HY11P41

Embedded 24-Bit  $\Sigma\Delta$ ADC

8-Bit RISC-like Mixed Signal Microcontroller

## 6.7.3. SD18, Temperature Sensor

$T_A = 25^\circ\text{C}$ ,  $V_{DD} = 3.0\text{V}$ ,  $V_{DDA} = 2.4\text{V}$ , unless otherwise noted

Sym.	Parameter	Test Conditions	Min.	Typ.	Max.	Unit
TC <sub>S</sub>	Sensor temperature drift			178		$\mu\text{V}/^\circ\text{C}$
KT	Absolute Temperature Scale $0^\circ\text{K}$	INBUF[0]=1		-289		$^\circ\text{C}$
TC <sub>ERR</sub>	One point calibrate error temperature	Calibration at $25^\circ\text{C}$ of $-40^\circ\text{C} \sim 85^\circ\text{C}$		$\pm 2$		$^\circ\text{C}$

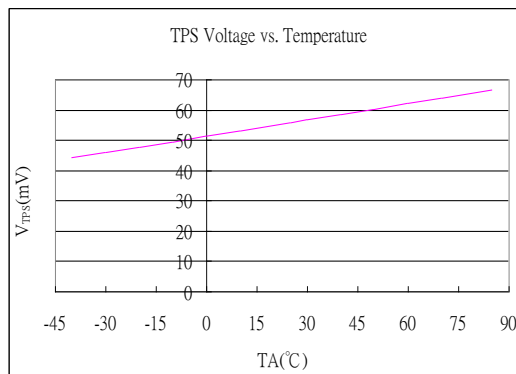

Figure 6.7-3 TPS Output Voltage vs. Temperature Drift

# HY11P41

Embedded 24-Bit  $\Sigma\Delta$ ADC  
8-Bit RISC-like Mixed Signal Microcontroller



## 6.7.4. SD18 Noise Performance

$T_A = 25^\circ\text{C}$ ,  $V_{DD} = 3.0\text{V}$ ,  $V_{DDA} = 2.4\text{V}$ , unless otherwise noted

HY11P41 provides important input noise specification that aims at SD18. Table 6.7-4(a) and Table 6.7-4(b) lists out the relations of typical noise specification, Gain, Output rate, and maximum input voltage of single end. Test condition configuration and external input signal short, voltage reference: 1.2V and 1024 records were sampled.

<b>ENOB(RMS) with OSR/GAIN at A/D Clock=250Khz, VDDA=2.4V, VREF=1.2V</b>														
Max. Vin(mV) =0.9*VREF <sup>(1)</sup>	OSR				128	256	512	1024	2048	4096	8192	16384	32768	
	Output rate(HZ)				1953	977	488	244	122	61	31	15	8	
	Gain	=	PGA	x										ADGN
$\pm 2400$	0.25	=	1	x	0.25	14.0	16.3	17.6	18.3	18.9	19.4	19.8	20.3	20.7
$\pm 2160$	0.5	=	1	x	0.5	13.9	16.2	17.5	18.2	18.8	19.3	19.7	20.2	20.6
$\pm 1080$	1	=	1	x	1	14.0	16.2	17.4	18.1	18.6	19.1	19.5	19.9	20.4
$\pm 540$	2	=	1	x	2	13.9	16.1	17.3	17.9	18.4	18.9	19.4	19.8	20.2
$\pm 270$	4	=	1	x	4	13.9	16.0	17.0	17.7	18.1	18.6	19.1	19.6	20.0
$\pm 135$	8	=	1	x	8	13.9	15.9	16.7	17.3	17.8	18.2	18.8	19.2	19.7
$\pm 68$	16	=	1	x	16	13.8	15.6	16.3	16.8	17.3	17.8	18.3	18.8	19.3
$\pm 34$	32	=	2	x	16	13.5	14.8	15.4	15.9	16.4	16.9	17.4	17.9	18.4
$\pm 17$	64	=	4	x	16	13.4	14.5	15.0	15.5	16.0	16.5	17.0	17.5	18.1
$\pm 8$	128	=	8	x	16	13.1	14.1	14.6	15.1	15.6	16.1	16.6	17.1	17.6

(1) Max.Vin (mV) is the max. input voltage of single end to ground (VSS).

Table 6.7-4(a) SD18 ENOB Table

<b>RMS Noise(uV) with OSR/GAIN at A/D Clock=250Khz, VDDA=2.4V, VREF=1.2V</b>														
Max. Vin(mV) =0.9*VREF	OSR				128	256	512	1024	2048	4096	8192	16384	32768	
	Output rate(HZ)				1953	977	488	244	122	61	31	15	8	
	Gain	=	PGA	x										ADGN
$\pm 2400$	0.25	=	1	x	0.25	680.48	122.16	47.79	29.08	20.02	14.45	10.35	7.55	5.90
$\pm 2160$	0.5	=	1	x	0.5	355.63	63.41	25.72	15.67	10.78	7.66	5.63	3.99	2.97
$\pm 1080$	1	=	1	x	1	166.02	31.71	13.93	8.63	5.99	4.35	3.22	2.41	1.76
$\pm 540$	2	=	1	x	2	85.85	16.80	7.72	4.96	3.49	2.49	1.81	1.33	0.98
$\pm 270$	4	=	1	x	4	43.52	9.19	4.53	2.93	2.12	1.51	1.08	0.78	0.59
$\pm 135$	8	=	1	x	8	22.18	5.10	2.83	1.91	1.33	0.97	0.67	0.49	0.35
$\pm 68$	16	=	1	x	16	11.97	3.08	1.88	1.30	0.91	0.66	0.46	0.33	0.23
$\pm 34$	32	=	2	x	16	6.75	2.63	1.79	1.24	0.87	0.62	0.44	0.32	0.22
$\pm 17$	64	=	4	x	16	3.75	1.68	1.12	0.80	0.56	0.42	0.28	0.20	0.14
$\pm 8$	128	=	8	x	16	2.16	1.09	0.78	0.55	0.38	0.27	0.19	0.13	0.10

Table 6.7-4(b) SD18 RMS Noise Table

The RMS noise is referred to the input. The Effective Number of Bits (ENOB (RMS Bit)) is defined as:

$$\text{ENOB(RMS)} = \frac{\ln\left(\frac{\text{FSR}}{\text{RMS Noise}}\right)}{\ln(2)}$$

$$\text{RMS Noise} = \frac{\left(2 \times \text{VREF} \times \sqrt{\sum_{k=1}^{1024} (\text{ADO}[k] - \text{Average})^2}\right)}{2^{23}}$$

Where FSR (Full - Scale Range) =  $2 \times \text{VREF}/\text{Gain}$ .

$$\text{Average} = \frac{\sum_{k=1}^{1024} (\text{ADO}[k])}{1024}$$

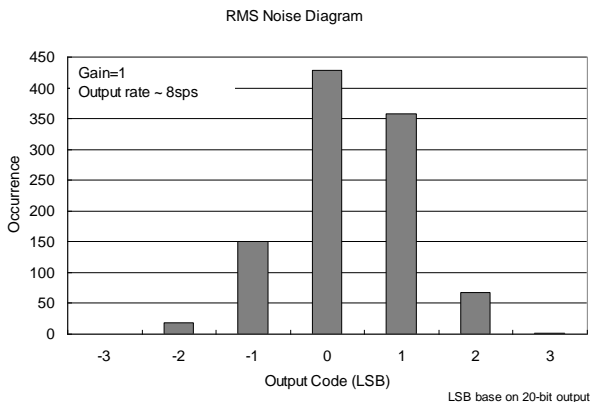

Figure 6.7-4(a) RMS Noise Diagram

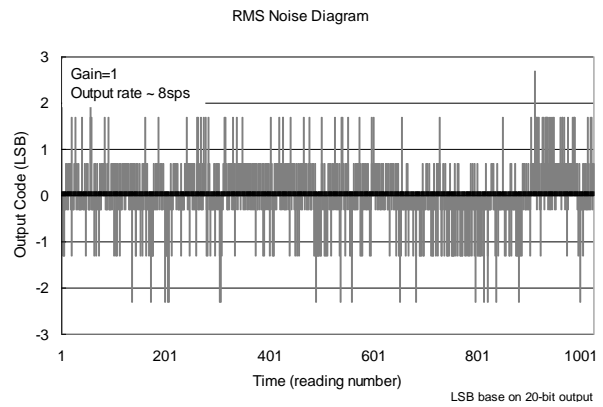

Figure 6.7-4(b) Output Code Diagram

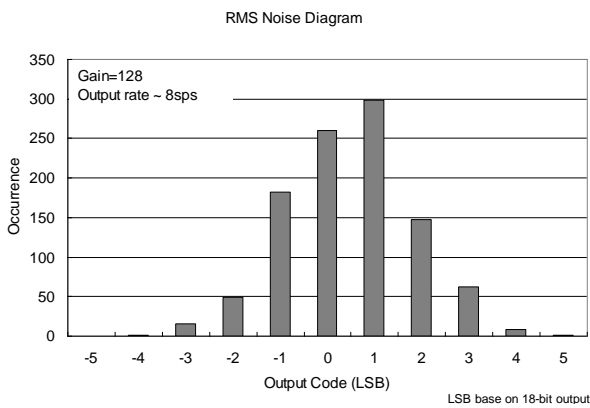

Figure 6.7-4(c) RMS Noise Diagram

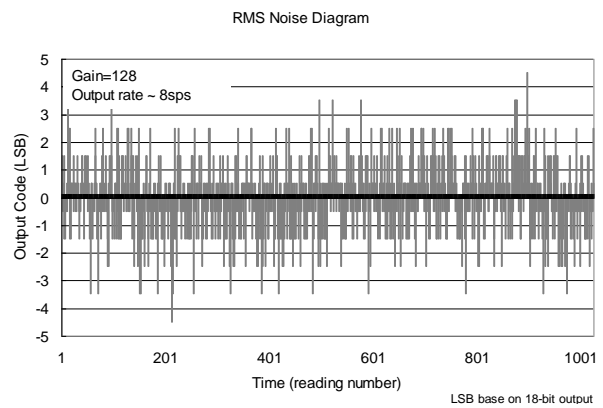

Figure 6.7-4(d) Output Code Diagram

# HY11P41

Embedded 24-Bit  $\Sigma\Delta$ ADC  
8-Bit RISC-like Mixed Signal Microcontroller



## 6.8. Built-in EPROM (BIE)

$T_A = 25^\circ\text{C}$ ,  $V_{DD} = 3.0\text{V}$ , unless otherwise noted

Sym.	Parameter	Test Conditions	Min.	Typ.	Max.	Unit
$V_{BIE}$	Supply Voltage			6.0	6.5	V
$I_{BIE}$	Operation supply current			5		mA
$V_{SS}$	Supply Voltage			0		V



# HY11P41

Embedded 24-Bit  $\Sigma$ ADC  
8-Bit RISC-like Mixed Signal Microcontroller

## 7. Ordering Information

Device No. <sup>1</sup>	Package Type	Pins	Package Drawing		Code <sup>2</sup>	Shipment Packing Type	Unit Q'ty	Material Composition	MSL <sup>3</sup>
HY11P41-D000	Die	-	D	000	000	-	250	Green <sup>4</sup>	-
HY11P41-E016	SSOP	16	E	016	000	Tube	100	Green <sup>4</sup>	MSL-3
HY11P41-E016	SSOP	16	E	016	000	Tape & Reel	2500	Green <sup>4</sup>	MSL-3
HY11P41-S016	SOP	16	S	016	000	Tube	50	Green <sup>4</sup>	MSL-3
HY11P41-S016	SOP	16	S	016	000	Tape & Reel	2500	Green <sup>4</sup>	MSL-3
HY11P41-N016	QFN	16	N	016	000	Tape & Reel	5000	Green <sup>4</sup>	MSL-3

**<sup>1</sup> Device No. Model No. – Package Type Description – Code** (Blank Code/ Standard/ Customized Programming Code)

Ex: Your customized programming code is 008 and you require die shipment.

The device No. will be HY11P41-D000-008

Ex: You request blank code in die package.

The device No. will be HY11P41-D000

Ex: You request blank code in SSOP16 package.

The device No. will be HY11P41-E016

And please clearly indicate the shipment packing type when placing orders.

Ex: Your customized programming code is 009 and you require products in SOP16 package.

The device No. will be HY11P41-S016-009.

And please clearly indicate the shipment packing type when placing orders.

### **<sup>2</sup> Code**

“001”~ “999” is standard or customized programming code. Blank code does not have these numbers.

### **<sup>3</sup> MSL**

The Moisture Sensitivity Level ranking conforms to IPC/JEDEC J-STD-020 industry standard categorization. The products are processed, packed, transported and used with reference to IPC/JEDEC J-STD-033.

### **<sup>4</sup> Green (RoHS & no Cl/Br)**

HYCON products are Green products that are compliant with RoHS directive, SVHC under REACH and Halogen free.

# HY11P41

Embedded 24-Bit  $\Sigma\Delta$ ADC  
8-Bit RISC-like Mixed Signal Microcontroller

## 8. Package Information

### 8.1. SSOP16 (E016)

#### 8.1.1. Package Dimensions

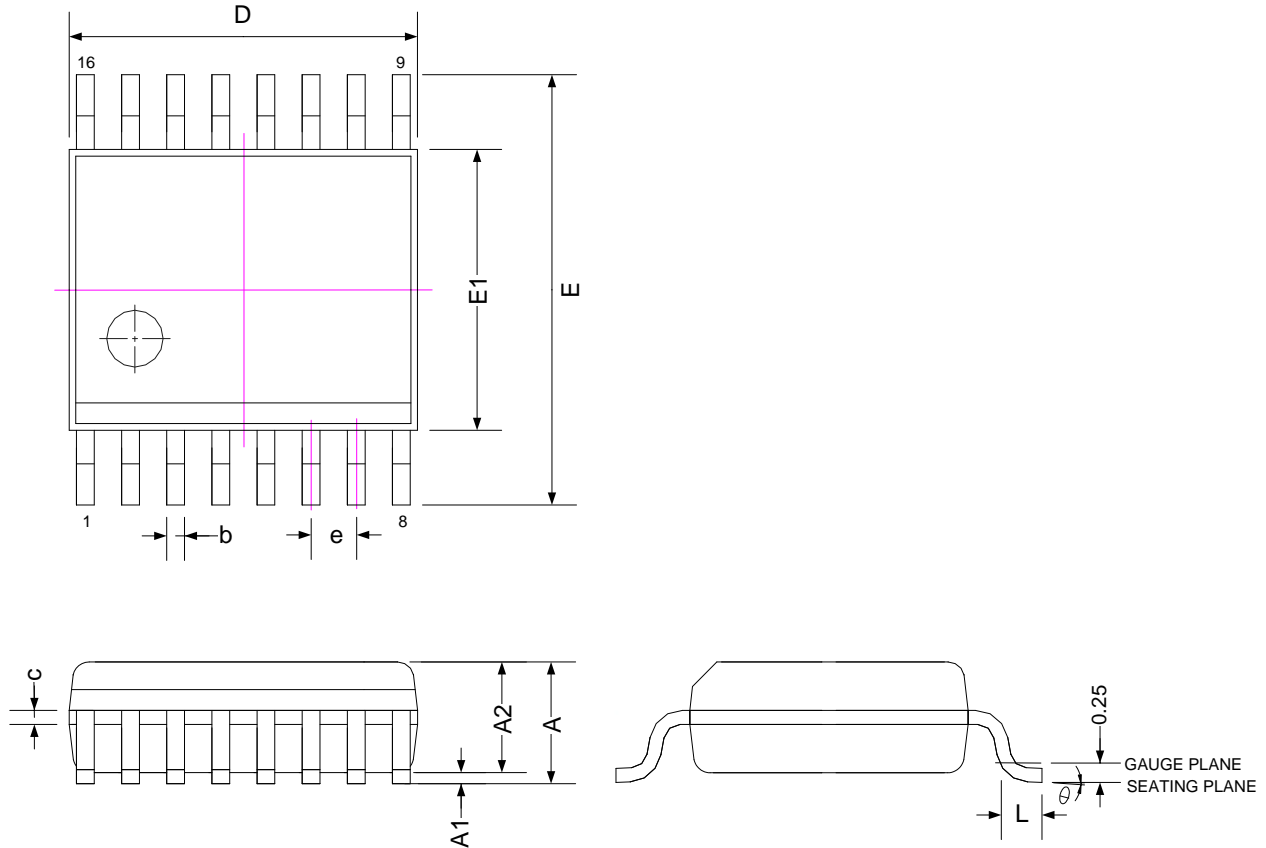

SYMBOLS	MIN	NOM	MAX
A	-	-	1.75
A1	0.10	0.15	0.25
A2	-	-	1.50
b	0.20	-	0.30
c	0.18	-	0.25
D	4.80	4.90	5.00
E1	3.81	3.91	3.99
E	5.79	5.99	6.20
L	0.41	-	1.27
e	0.635 BASIC		
$\theta^\circ$	0	-	8

Note:

1. All dimensions refer to JEDEC OUTLINE MO-137.
2. Do not include Mold Flash or Protrusions.
3. Unit : mm.

# HY11P41

Embedded 24-Bit  $\Sigma\Delta$ ADC  
8-Bit RISC-like Mixed Signal Microcontroller

## 8.1.2. Tube Dimensions SSOP16(E016)

Unit : mm

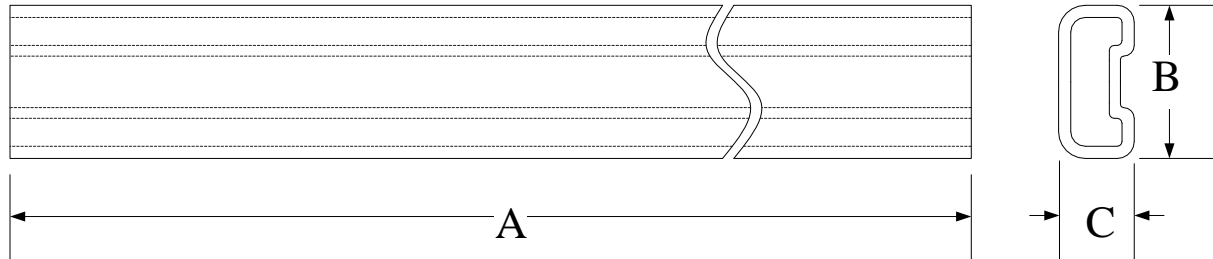

Type 1:

SYMBOLS	A	B	C
Spec.	521.0 $\pm$ 1.0	7.747 $\pm$ 0.15	3.810 $\pm$ 0.15

Type 2:

SYMBOLS	A	B	C
Spec.	521.0 $\pm$ 1.0	7.874 REF.	3.810 REF.

# HY11P41

Embedded 24-Bit  $\Sigma\Delta$ ADC  
8-Bit RISC-like Mixed Signal Microcontroller



## 8.1.3. Tape & Reel Information

### 8.1.3.1. Reel Dimensions –Type1

Unit : mm

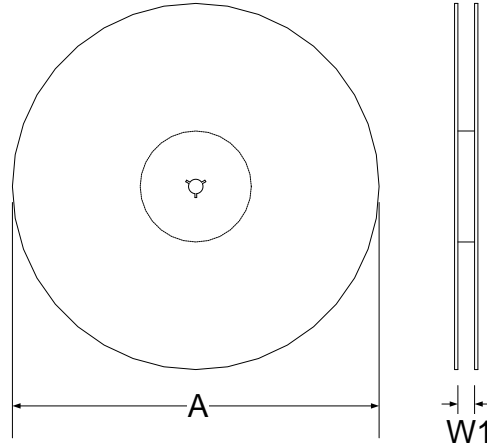

### 8.1.3.2. Carrier Tape Dimensions

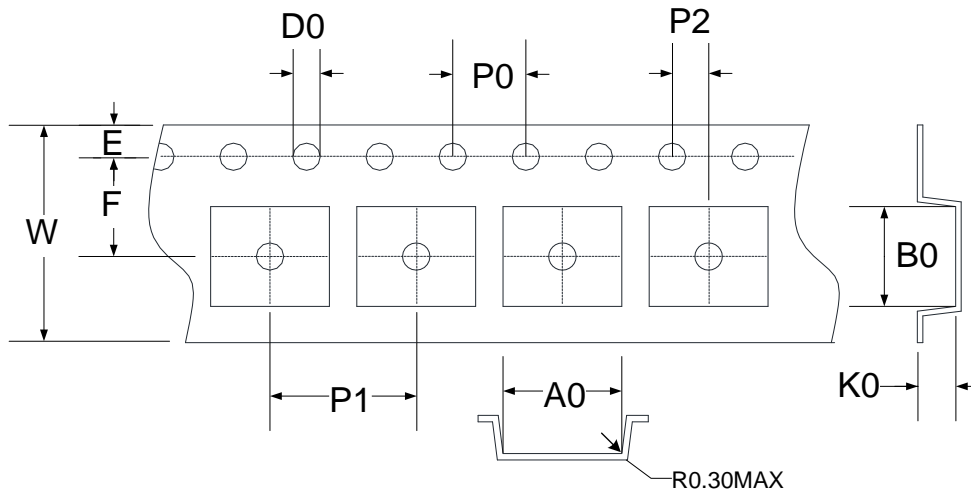

SYMBOLS	Reel Dimensions		Carrier Tape Dimensions										
	A	W1	A0	B0	K0	P0	P1	P2	E	F	D0	W	
Spec.	330	12.5	6.90	5.40	2.00	4.00	8.00	2.00	1.75	5.50	1.50	12.00	
Tolerance	+6/-3	+1.5/-0	±0.10	±0.10	±0.10	±0.10	±0.10	±0.10	±0.05	±0.10	±0.05	+0.1/-0	±0.30

### 8.1.3.3. Pin1 direction

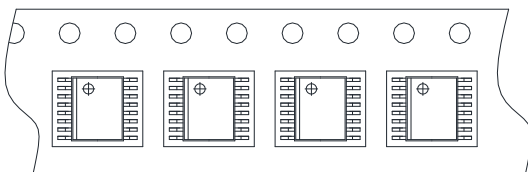

# HY11P41

Embedded 24-Bit  $\Sigma\Delta$ ADC  
8-Bit RISC-like Mixed Signal Microcontroller

## 8.2. SOP16(S016)

### 8.2.1. Package Dimensions

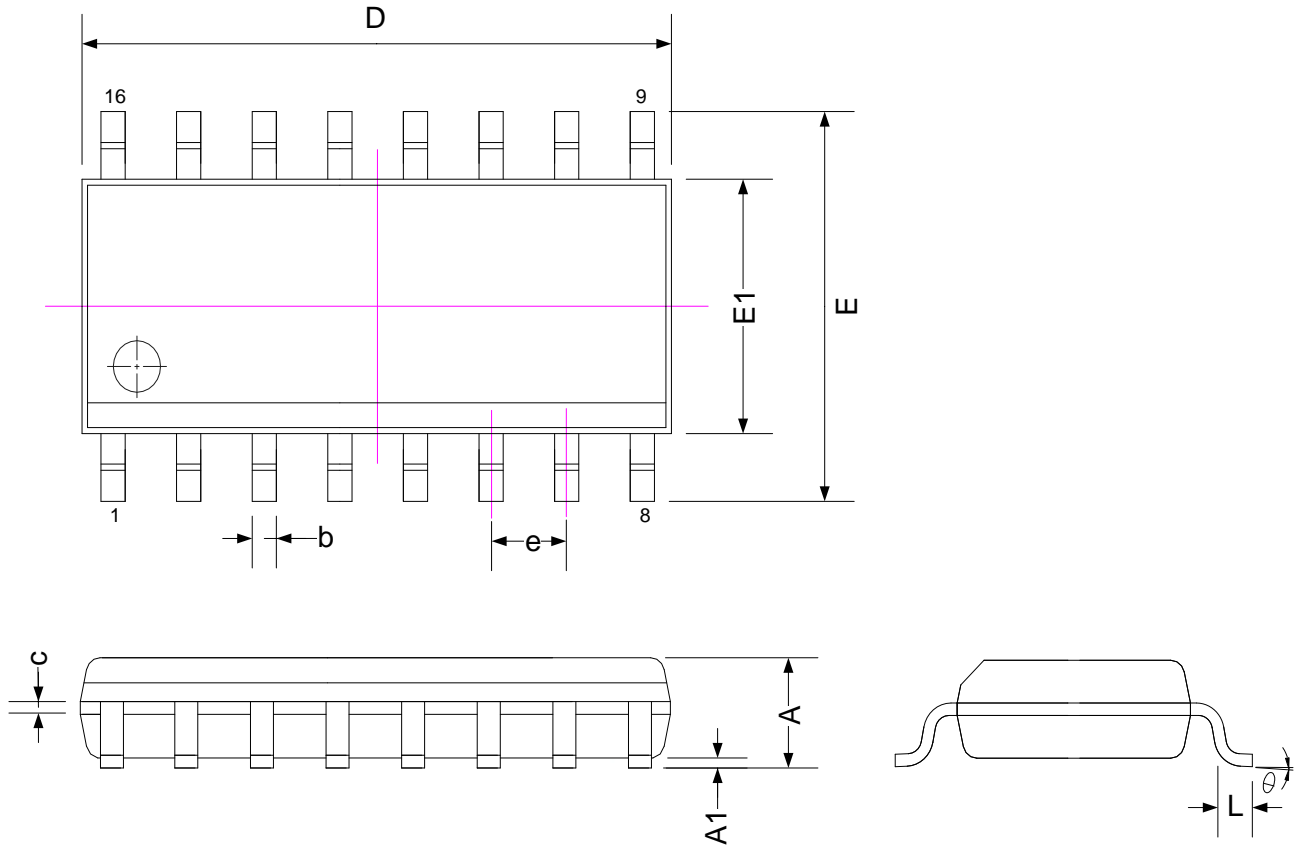

SYMBOLS	MIN	NOM	MAX
A	-	-	1.75
A1	0.10	-	0.25
b	0.31	-	0.51
c	0.10	-	0.25
D	9.90 BASIC		
E1	3.90 BASIC		
E	6.00 BASIC		
L	0.40	-	1.27
e	1.27 BASIC		
$\theta$	0	-	8

Note :

1. All dimensions refer to JEDEC OUTLINE MS-012.
2. Do not include Mold Flash or Protrusions.
3. Unit: mm.

# HY11P41

Embedded 24-Bit  $\Sigma\Delta$ ADC  
8-Bit RISC-like Mixed Signal Microcontroller

## 8.2.2. Tube Dimensions SOP16(S016)

Unit : mm

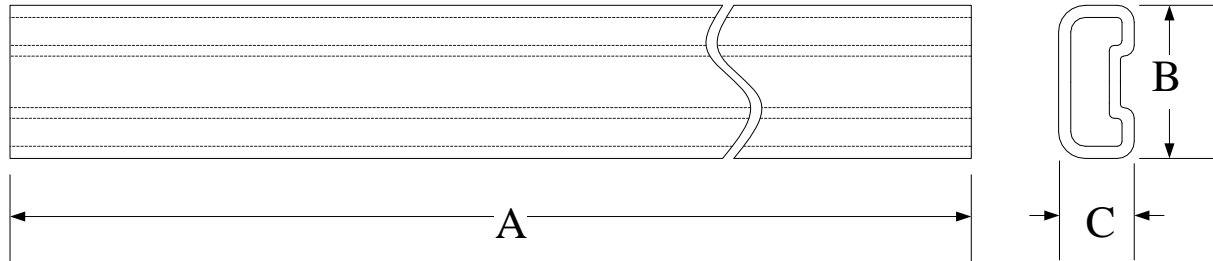

Type 1:

SYMBOLS	A	B	C
Spec.	521.0±1.0	7.747±0.15	3.810±0.15

Type 2:

SYMBOLS	A	B	C
Spec.	521.0±1.0	7.874 REF.	3.810 REF.

# HY11P41

Embedded 24-Bit  $\Sigma\Delta$ ADC  
8-Bit RISC-like Mixed Signal Microcontroller



## 8.2.3. Tape & Reel Information

### 8.2.3.1. Reel Dimensions –Type1

Unit : mm

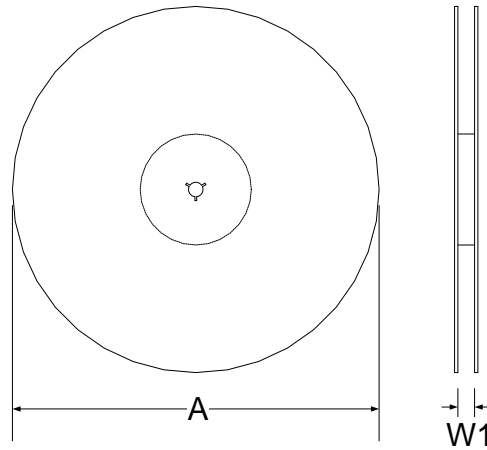

### 8.2.3.2. Carrier Tape Dimensions

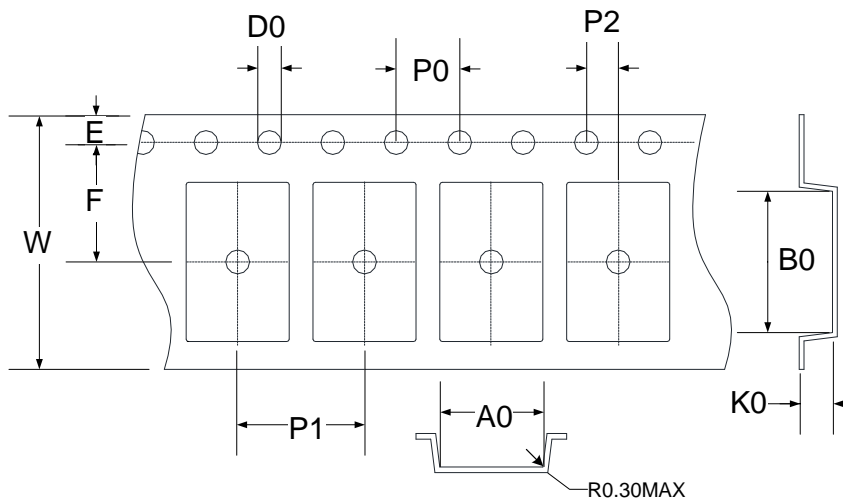

SYMBOLS	Reel Dimensions		Carrier Tape Dimensions									
	A	W1	A0	B0	K0	P0	P1	P2	E	F	D0	W
Spec.	330	16.5	6.50	10.30	2.10	4.00	8.00	2.00	1.75	7.50	1.50	16.00
Tolerance	+6/-3	+1.5/-0	±0.10	±0.10	±0.10	±0.10	±0.10	±0.05	±0.10	±0.10	+0.1/-0	±0.30

### 8.2.3.3. Pin1 direction

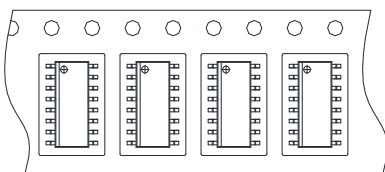

# HY11P41

Embedded 24-Bit  $\Sigma\Delta$ ADC  
8-Bit RISC-like Mixed Signal Microcontroller

## 8.3. QFN16(N016)

### 8.3.1. Package Dimensions

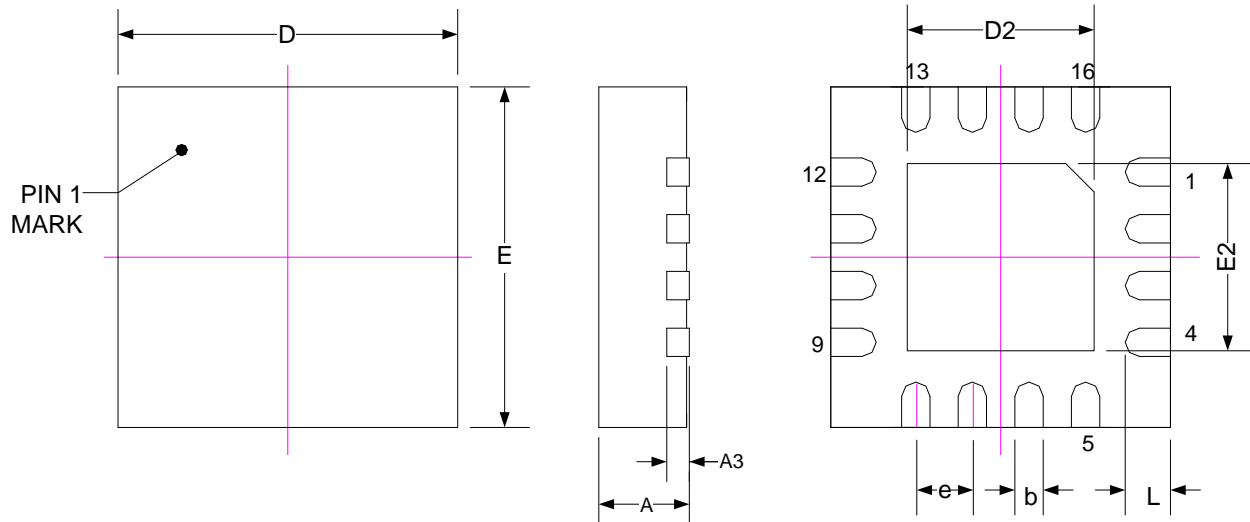

SYMBOLS	MIN	NOM	MAX
A	0.70	0.75	0.80
A3	0.203 REF.		
b	0.20	0.25	0.30
D	2.925	3.000	3.075
E	2.925	3.000	3.075
D2	1.625	1.725	1.825
E2	1.625	1.725	1.825
L	0.30	0.35	0.40
e	0.50 BASIC		



# HY11P41

Embedded 24-Bit  $\Sigma\Delta$ ADC  
8-Bit RISC-like Mixed Signal Microcontroller



## 8.3.2. Tape & Reel Information

### 8.3.2.1. Reel Dimensions –Type1

Unit : mm

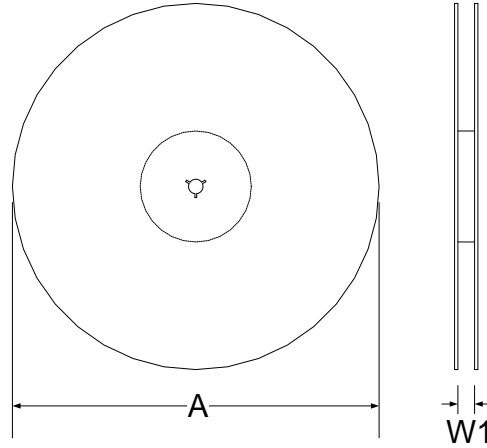

### 8.3.2.2. Carrier Tape Dimensions

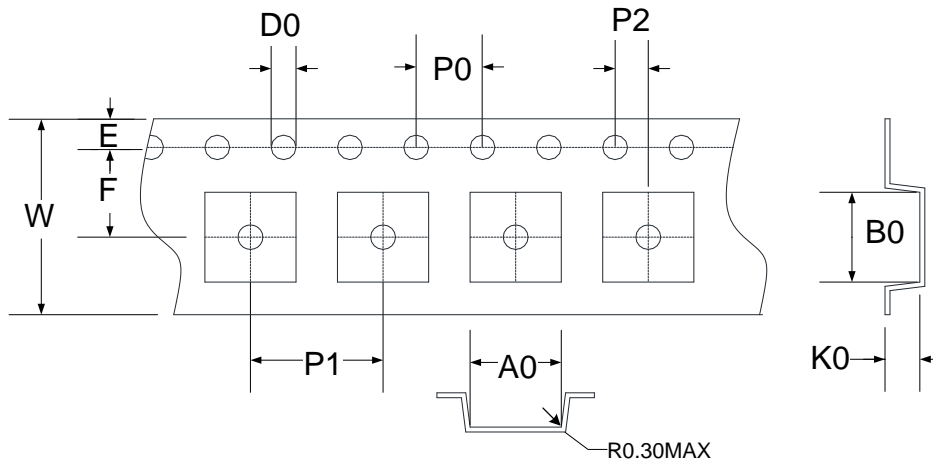

SYMBOLS	Reel Dimensions		Carrier Tape Dimensions									
	A	W1	A0	B0	K0	P0	P1	P2	E	F	D0	W
Spec.	330	12.5	3.30	3.30	1.10	4.00	8.00	2.00	1.75	5.50	1.50	12.00
Tolerance	+6/-3	+1.5/-0	±0.10	±0.10	±0.10	±0.10	±0.10	±0.05	±0.10	±0.05	+0.1/-0	±0.30

### 8.3.2.3. Pin1 direction

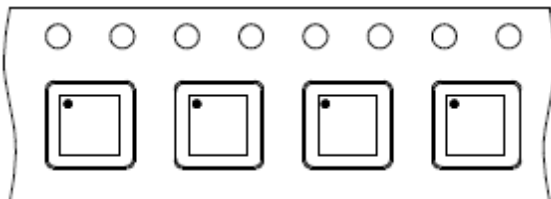

# HY11P41

Embedded 24-Bit  $\Sigma$ ADC  
8-Bit RISC-like Mixed Signal Microcontroller

## 9. Revisions

The following describes the major changes made to the document, excluding the punctuation and font changes.

Version	Page	Date	Revision Summary
V06	All	2011/04/06	First edition
V07	13	2011/04/22	Add in note of SD18 Network
V08	7,10~13, 35,38	2011/05/12	Add in QFN16 package type related information
V09	5~17, 19	2011/07/08	Add in the related description and figures of Serial communication SPI module
V10	5~17, 19	2011/08/17	Delete the related description and figures of Serial communication SPI module
V11	5	2012/03/14	Add the description of fast start function
	14~16		Update the application circuits
	29		Delete the description related to INBUF and VRBUF function of ADC
	36~37		Update the package information of SSOP16 and SOP16
V12	6~16, 20	2013/04/01	Update PT1.1/TST pin description
V13	35	2014/01/27	HY11P41-N016 ordering information (3000/Reel revise to 5000/Reel)
V14	5	2016/11/14	Add in Function List
	11~12		Update Package marker information
	33		Update Green (RoHS & no Cl/Br)
	36,39,41		Update Tape & Reel Information
V15	All	2019/03/05	Correct the description of the ADC resolution to 24-Bit $\Sigma$ ADC
	35,38		Update Tube Dimensions